

LZ102CT

Sink material	Composite
Type	Composite sink
No. of bowls	1 + 1/2
Drainer	Reversible
EAN code	8017709251697

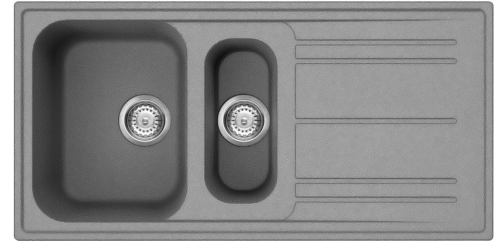

Aesthetics



Aesthetic	Universale	Logo	Applied/on overflow
Series	Rigae	Alternative colours available	White, Anthracite, Cream, Beige, Copper
Colour	Cement / Concrete	Half bowl cup drainer	Yes
Building in type	Standard	Tap hole / precut tap hole	Prepared

	Bowl type RH	Bowl dimensions, WxDxH (mm)	Bowl depth (mm)	Radius corner right bowl (mm)	Overflow LH bowl	Strainer position	Strainer dimension
RH Bowl	Half bowl	150 x 340 x 168	168	50		Centre of bowl	3.5"
LH Bowl	Traditional	420 x 320 x 210	210	80	Yes, traditional	Side bowl	3.5"

Technical Features



Characteristics composite material	Antibacterial, Easy to clean, Anti-scratch, Thermal shock resistant, High temperatures resistant, Impact resistant, UV Resistant	Tap hole	2
Frame depth (mm)	10	Tap hole diameter	35 mm
		Dividing wall width	38 mm
		Drainer inclination	2 °
		No. of clips	10
		Type of clips	Standard

Dimensions of the product (mm)	210x1000x500 mm
Cutout dimension topmount (mm)	980 X 480 mm
Undermount cutout radius	30 mm
Height from kitchen top	10 mm
Base unit size	60 cm

Accessories Included

Accessories for installation	Strainer, Savespace siphon with dishwasher outlet connection, Fixing clips
------------------------------	--

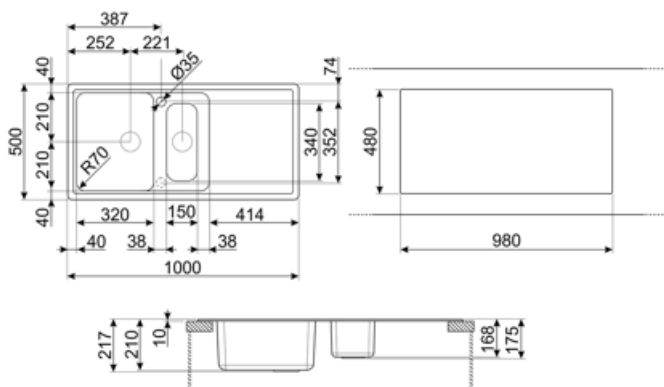

Not included accessories



KITDSQ

Soap dispenser chrome finishing with square knob 40x40 mm



KITFD075

Waste disposal 0,75 HP, Motor: 1/2 horsepower, Fits all sinks with 3 1/2" waste outlet



KITFD050













Waste disposal 0,5 HP, Motor: 1/2 horsepower, Fits all sinks with 3 1/2" waste outlet



KITFD100

Waste disposal 1 HP, Motor: 1/2 horsepower, Fits all sinks with 3 1/2" waste outlet

Symbols glossary

	Antibacterial		Antiscratch
	Cupboard width required for sink installation		Sink depth - depending on the model, the depth can be from 13 to 24,5
	Sink depth - depending on the model, the depth can be from 13 to 24,5		Standard installation: Traditional installation in tabletop, suitable for any kitchen sets
	Easy to clean		High temperatures resistant
	Impact resistant		Thanks to the double tap hole, most of our sinks are easily reversible, giving you the flexibility to make any type of kitchen composition.
	Thermal shock resistant		UV protection, does not fade over time.

Benefit (TT)

Two bowls

Two bowls for greater versatility and dual functionality

Drainer

The drawer allows dishes, cutlery and kitchen utensils to be placed directly on the sink after washing: excess water can drain into the sink, allowing for natural drying

Double tap hole

The sink is easily reversible, making it possible to create any type of kitchen composition

Tap hole possibility

Possibility of having the tap hole for direct installation of the tap on the sink, for a larger and neater surface area