

# MOE34CXIUK

Usable volume

34 l



Product Family

Microwave

Category

Freestanding

Power supply

Electric

Cooking Method

Combi Microwave

Control

Electronic



## Controls

Display / Clock

1 a LED

Type of control setting

Control knobs / buttons

Opening

Handle

No. of controls

1

Control knobs

Standard with knurlings

Controls colour

Chromed

Buttons Colour

Chrome

## Options



Timer

Electronic

Time-setting options

Start and stop

End of cooking acoustic alarm

Yes

Controls Lock / Child Safety

Yes

## Technical Features



Cavity material

Stainless steel

No. of lights

1

Light type

LED

Turntable

Yes

Turntable dimensions

31.5 cm

Light when door is opened

Yes

Grill type

Heating element

Grill - power

1100 W

Door opening

Side-opening

Total no. of door glasses

2

Safety Thermostat

Yes

Cooling system

Tangential

Microwave screen protection

Yes

Microwave stops when door is opened

Yes

Inverter

Yes

<b>Circulaire heating element - Power</b>	2500 W	<b>Usable cavity space dimensions (HxWxD)</b>	249x351x361 mm
		<b>Microwave effective power</b>	1100 W

## Accessories Included







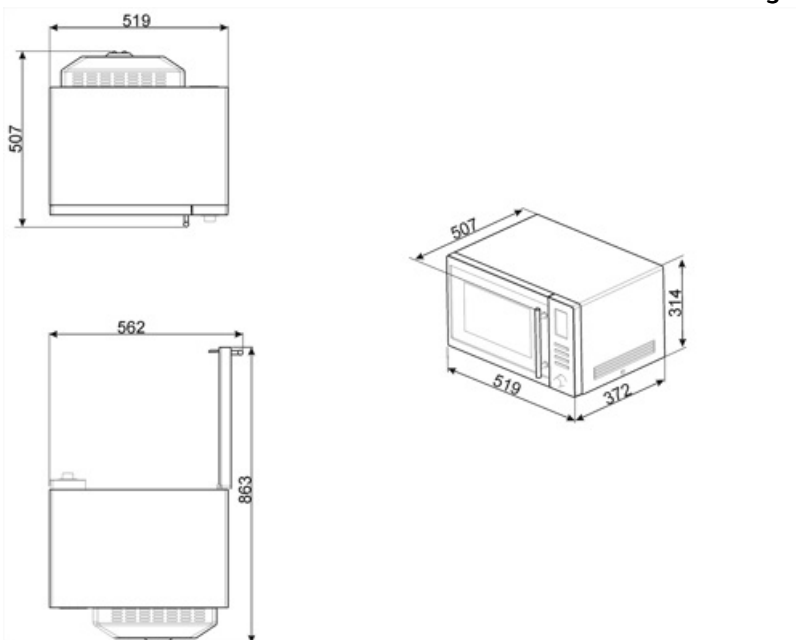









<b>Grid</b>	1
-------------	---

## Electrical Connection

<b>Plug</b>	(G) UK e Singapore	<b>Voltage (V)</b>	230 V
<b>Nominal power (W)</b>	1800 W	<b>Frequency (Hz)</b>	50 Hz
<b>Current</b>	7,83 A	<b>Power supply cable length</b>	100 cm



## Symbols glossary

 <p>Child lock: some models are fitted with a device to lock the programme/cycle so it cannot be accidentally changed.</p>	 <p>Combination microwave: This oven allows to combine two different ways of cooking (Traditional with microwaves). Combined ovens increase cooking opportunities, while providing maximum flexibility of household appliances.</p>
 <p>Microwave energy shortens cooking times dramatically and produces energy savings.</p>	 <p>Defrost by time: with this function the time of thawing of foods are determined automatically.</p>
 <p>Defrost by weight: With this function the defrosting time is determined</p>	 <p>Double glazed doors: Number of glazed doors.</p>
 <p>Fingerprint proof stainless steel: Fingerprint proof stainless steel keeps stainless steel looking as good as new.</p>	 <p>Circulaire + grill: Circulaire with upper element or grill: Similar to fan with upper element with the added cooking speed of circulaire, ideal for dishes with a crispy topping. When used with the grill the food will brown more quickly.</p>
 <p>Circulaire: The combination of the fan and circular element around it gives a hot air cooking method. This provides many benefits including no preheat if cook time is more than 20 minutes, no flavour transfer when cooking different foods at the same time, less energy, and shorter cook times. Good for all types of food.</p>	 <p>Grill element: Using of grill gives excellent results when cooking meat of medium and small portions, especially when combined with a rotisserie (where possible). Also ideal for cooking sausages and bacon.</p>
 <p>Fan with grill element: The fan reduces the fierce heat from the grill, providing an excellent method of grilling various foods, chops, steaks, sausages etc. giving even browning and heat distribution, without drying out the food. The top two levels recommended for use, and the lower part of the oven can be used to keep items warm at the same time, an excellent facility when cooking a grilled breakfast. Half grill (centre portion only) is ideal for small quantities of food.</p>	 <p>Microwave: Penetrating straight into the food, microwaves cook very quickly and with considerable energy savings. Suitable for cooking without fat, they are also able to thaw and heat food without altering its original appearance and aroma. The microwave function can also be combined with conventional functions with all the resulting advantages. Ideal for all types of food.</p>
 <p>Cooking with the simultaneous use of the heating element in combination with fan and microwave supply.</p>	 <p>Microwave + grill element: The use of the grill results in a perfect browning of the surface of the food. The action of microwaves allows instead of cooking in a short time the internal part of the food.</p>
 <p>Pizza microwave: This function cooks pizza quicker thanks to the microwaves. To optimize the final result, use the function combined with the Chef plate</p>	 <p>Side lights: Two opposing side lights increase visibility inside the oven.</p>
 <p>The capacity indicates the amount of usable space in the oven cavity in litres.</p>	