

## RC20XNC



Product Family	Refrigerator
Installation	Free standing
Category	Bottom Mount
Reference width	Until 60
Reference height	160 - 200
Sistema Total No - Frost	Yes
Cooling type	Total No Frost
Defrost	Automatic
Hinge type	Standard
Hinge position	Right
Reversible door	Yes
EAN code	8017709343293



## Aesthetics



Aesthetic	Universale	Side material	Steel
Colour	Inox-look	Side colour	Silver
Material	Steel Effect	Logo	Applied
Handle	Integrated	Display	LED
Handle type	Fixed	Display position	Interno (sul Top)
Logo colour	Chrome		

## Refrigerator compartment features



No. of adjustable shelves	3	Type of crisper/vegetable drawers cover	Glass
Number of fruit and vegetables drawers	1	No. of lights refrigerator compartment	1
Type of adjustable shelves	Glass	Low temperature compartment	Yes
Type of crisper/vegetable drawers cover	On sliding rails	Internal light in fridge	Yes
Crisper Cover	Yes	Type of internal light (fridge)	LED
Bottle shelf	Yes		

## Refrigerator Inner Door

Number of adjustable door shelves	3	No. of bottle shelves	1
-----------------------------------	---	-----------------------	---

## Other Refrigerator features



Accessories Bottle holder, Egg tray **MultiFlow** Yes

## Freezer compartment features

Number of drawers 3

## Other Freezer features

Accessories 1 ice box

## Other technical features



Functions display	Fast freezing, ECO
Door open alarm	Yes
Temperature Alarm	Yes
Type of temperature control	Electronic
No. of compressors	1
Refrigerant gas type	R600a
Type of compressor	Inverter
Foam agent	Cyclopentane

## Performance / Energy Label - Reg. 2019



Annual energy consumption	158 kWh/a	Airborne acoustical noise emissions	35 dB(A) re 1 pW
Energy efficiency class	C	Temperature Rise Time	10 h
Airborne acoustical noise emission class	B	4 star - Freezing capacity	10.0 Kg/24h
Total net volume	331 l	Climate class	SN, N, ST, T
Sum of the volumes of the frozen compartment(s)	96 l	EI	64 %
Sum of the volumes of the chill compartment(s) and the unfrozen compartment(s)	235 l		

## Electrical Connection

Plug (F;E) Schuko Voltage (V) 220-240 V

Electrical connection rating  
Current







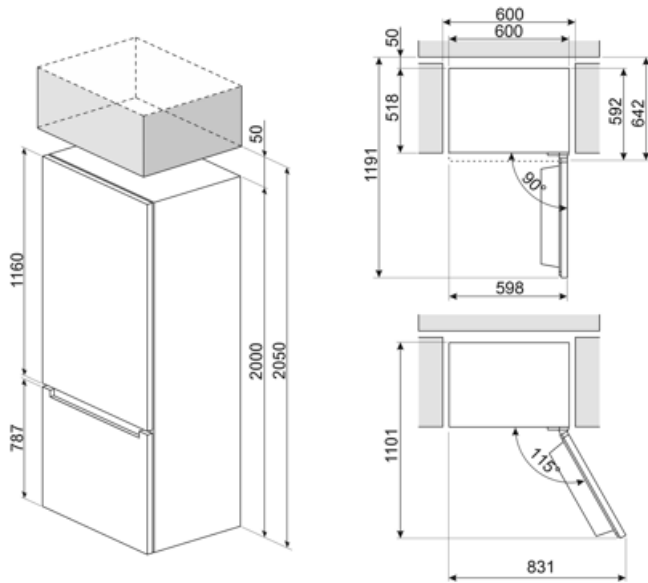

200 W  
0,9 A

Frequency (Hz)  
Power supply cable length

50 Hz  
200 cm



## Symbols glossary

- |  |  |   |  |
|--|--|---|--|
|  | The automatic defrost system works by automatically defrosting at regular intervals eliminating the need to defrost altogether.                          |  | Energy efficiency class C  |
|  | LED display: to show programmes, functions and options selected and the time to the end of the cycle.  |  | Economical mode: Analyzes fridge functioning during the activation and optimizes the operating cycle in order to reduce power consumption. |
|  | Fast freezing: The fast freezing function brings the temperature of the compartment down when activated a few hours prior to usage.                      |  | LED interior lighting: is a more energy efficient and long lasting way of illuminating the interior of the appliance.                      |
|  | Smeg's evolution towards more intelligent and eco-friendly models has led to the choice of Inverter technology, which significantly reduces consumption. |  | Multiflow Cooling System: the Multiflow ventilation system allows an even distribution of cool air around the fridge cabinet.              |