

RC21KDNMC



Product Family	Refrigerator
Installation	Free standing
Category	Bottom Mount
Reference width	Until 60
Reference height	160 - 200
Cooling type	Total No Frost
Defrost	Automatic
Hinge type	Standard
Hinge position	Right
Reversible door	Yes
EAN code	8017709344740



Aesthetics



Aesthetic	Universale	Side colour	Silver
Colour	Dark Inox Look	Logo	Applied
Material	Metal sheet	Door shelves profile color	Silver
Handle	Integrated	Drawers profile color	Silver
Handle type	Fixed	Color of glass shelf profile	Chrome
Logo colour	Chrome	Display	LED
Side material	Steel	Display position	Esterno (su porta)

Refrigerator compartment features



No. of adjustable shelves	3	Type of crisper/vegetable drawers cover	Glass
Number of fruit and vegetables drawers	1	No. of lights refrigerator compartment	1
Type of adjustable shelves	Glass	Life Plus zone-0°C	Yes
Type of crisper/vegetable drawers cover	On sliding rails	Internal light in fridge	Yes
Crisper Cover	Yes	Type of internal light (fridge)	LED
Bottle shelf	Yes		

Refrigerator Inner Door

Number of adjustable door shelves	3	No. of bottle shelves	1
--	----------	------------------------------	----------

Other Refrigerator features



Accessories	Cheese box, Egg tray	Ionizer	Yes
MultiFlow	Metal		

Freezer compartment features

Number of drawers	3
--------------------------	----------

Other Freezer features

Accessories	1 ice box
--------------------	------------------

Other technical features

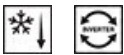

Functions display	Fast freezing
MultiZone	Yes
Temperature Alarm	Yes
Type of temperature control	Electronic
No. of compressors	1
Refrigerant gas type	R600a
Type of compressor	Inverter
Foam agent	Cyclopentane

Performance / Energy Label - Reg. 2019







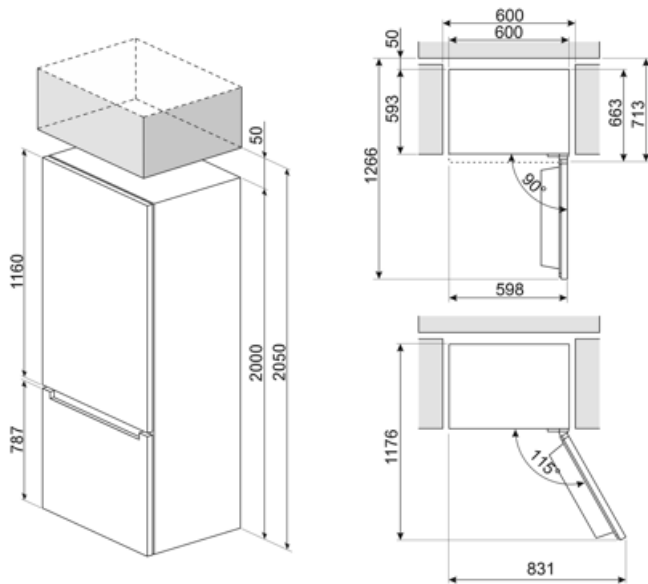

			
Annual energy consumption	169 kWh/a	Airborne acoustical noise emissions	35 dB(A) re 1 pW
Energy efficiency class	C	Temperature Rise Time	9 h
Airborne acoustical noise emission class	B	4 star - Freezing capacity	13.0 Kg/24h
Total net volume	361 l	Climate class	SN, N, ST, T
Sum of the volumes of the frozen compartment(s)	106 l	EEl	64 %
Sum of the volumes of the chill compartment(s) and the unfrozen compartment(s)	255 l		

Electrical Connection

Plug	(F;E) Schuko	Voltage (V)	220-240 V
Electrical connection rating	200 W	Frequency (Hz)	50 Hz
Current	0,9 A	Power supply cable length	200 cm



Symbols glossary

-  Smeg Active Ion system improves the quality of the air inside the cell. Thanks to the generation of negatively charged ions released inside the fridge Active Ion system neutralizes unpleasant dust.
-  LED display: to show programmes, functions and options selected and the time to the end of the cycle.
-  LED interior lighting: is a more energy efficient and long lasting way of illuminating the interior of the appliance.
-  Smeg's evolution towards more intelligent and eco-friendly models has led to the choice of Inverter technology, which significantly reduces consumption.
-  Multiflow Cooling System: the Multiflow ventilation system allows an even distribution of cool air around the fridge cabinet. The stainless steel panel gives a more premium look to the appliance.
-  The automatic defrost system works by automatically defrosting at regular intervals eliminating the need to defrost altogether.
-  Fast freezing: The fast freezing function brings the temperature of the compartment down when activated a few hours prior to usage.
-  Life Plus 0°C: The temperature in the Lifeplus compartments is kept at 0°C, which preserves fresh meat and fish longer.
-  Energy efficiency class C