

SBC4304X

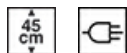

Familie	Blast chiller
Categorie	Compact 45 cm
Vitality system	Ja
Voeding	Elektrisch
Warmtebron	Elektrisch
Type koeling	Geventileerd



Design

Esthetiek	Classici	Alternative colours available	Stainless steel, Pure Black, Neptune Grey, Nero Lucido
Kleur	Roestvrij staal	Type glas	Zwart
Afwerking	Vingervlekvrij	Deur	Met 2 horizontale stroken
Design	Plat	Handgreep	Classici
Afwerking componenten	Roestvrij staal	Kleur handgreep	Rvs look
Materiaal	Roestvrij staal	Logo	In reliëf
Type roestvrijstaal	Geborsteld		

Program / Functions

Automatische programma's	8
Aantal verwarmingsfuncties	6
Aantal koelfuncties	5
Automatische reiniging	
Personaliseerbare recepten	100

Koude functies

 Bewaren	 Flessen koelen	 Invriezen
--	--	---

 Koeling	 Vooraf koelen
--	---

Opwarmfuncties

 Koken op lage temperatuur	 Rijsfunctie	 Gerecht verwarmen
--	---	---

Defrosting	Heating	Yoghurt
------------	---------	---------

Multi-step

Yes, up to 2 functions

Bediening



Display

TFT grafisch met kleuren
touch screen

Regeling bediening

Touch control

Opties



Alarm deur open

Ja

Timer

Ja

Timer

2

Kinderbeveiliging

Ja

Kerntemperatuurmeter

Ja

Koelen met

kerntemperatuurmeter

Ja

Showroom demo optie

Ja

Geluid

Polyphonic

Geheugen

Ja, de 10 laatst gebruikte
functies

Touch guide

Si, a pressione prolungata
su display

Technische specificaties



Type compressor

Standaard

Type koelmiddel

R290

Hoeveelheid koelmiddel

58 g

Klimaatklasse

SN, N, ST, T

Temperatuurregeling

Elektronisch

Minimum temperatuur

-28 °C

Maximum temperatuur

75 °C

Materiaal ovenruimte

Roestvrij staal

Aantal kookniveaus

3

Type ovenrekken

Metalen zijsteunen

Aantal lampen

1

Soort verlichting

Halogeen

Vermogen lamp

1 W

Automatische
inschakeling verlichting
bij openen deur

Ja

Bovenwarmte -
vermogen

250 W

Deur openen

Standaard opening

Veiligheidsthermostaat

Ja

Automatische
uitschakeling
verhittingselementen bij
openen deur

Ja

Bruto inhoud

34 l

Meegeleverde accessoires

Ovenrooster met stop

1

Bottle rack grid

Yes

Kerntemperatuurmeter

Ja

Overig

Microvezeldoek

Elektrische aansluiting

Stekker

(F;E) Schuko

Stroom







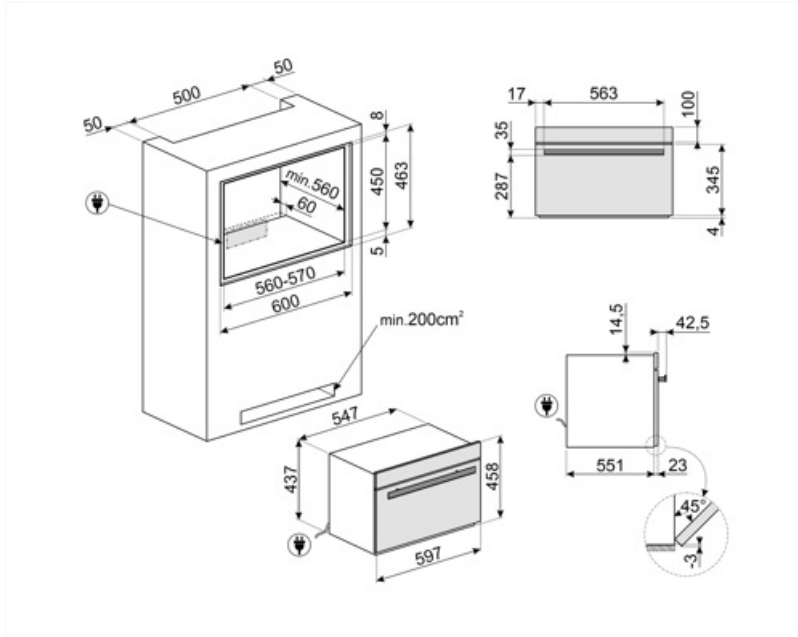







2,5 A

Spanning 220-240 V
Aansluitwaarde 270 W

Frequentie 50 Hz
Lengte voedingskabel 200 cm



Symbols glossary

	Kinderslot: sommige modellen zijn voorzien van een apparaat om het programma / de cyclus te vergrendelen zodat het niet kan per ongeluk veranderd		Cooling: It allows to quickly cool the food, from the temperature of 80/90°C to 3°C in less than 90 minutes, to prevent bacterial growth, prolong the average life of food and maintain unaltered the quality of food.
	Cold storage: allows to keep the food at the desired temperature between -35°C and +75°C and serve it at its best to enhance flavours and aromas.		Pre-cooling: allows the cavity to cool to -30 °C before inserting food into the blast chiller, to ensure the best cooling and freezing results. It is recommended to run a 15-minute pre-cooling cycle.
	Bottles cooling: is possible to quickly cool wine and beverage bottles, reducing the need for storage in the refrigerator, with considerable space savings. Cooling of beverages takes place at about 1°C per minute.		Deep freezing of the food is a very quick process (From 0/90°C temperature to -18°C in less than 270 min) that allows to extend the average life of food (by up to 70% more) and keep the same organoleptic and nutritional characteristics of fresh food, because it avoid the formation of macro-crystals, that ruin the fibers of the food.
	Electric		Vingerafdrukbestendig roestvrij staal: Vingerafdrukbestendig roestvrij staal zorgt ervoor dat roestvrij staal er zo goed als nieuw uitziet.
	Automatic cleaning: a drying cycle of the cavity to be run with the door open, to eliminate any condensation formed during use.		Compact appliances with a height of 45 cm - perfect solution to meet the functional requirements of kitchen sets of small height. Available in several types and in different styles.
	Touch control: dankzij de gebruiksvriendelijke Touch control kan het apparaat met één druk op de knop worden geprogrammeerd.		The capacity indicates the amount of usable space in the oven cavity in litres.
	Ready to eat: This function allows to keep food safely at the refrigerator temperature throughout the day, and heat it just before your return to make it warm, ready to be consumed.		Low temperature cooking: This function consists in cooking food at a constant temperature, lower than the traditional cooking temperature. Meat results more tender and juicy, maintaining a softness that only this cooking technique allows to obtain.
	Dough leavening/ Yogurt: this function allows you to create the perfect conditions for correct leavening, keeping the mixture at controlled temperatures for the desired time, avoiding sudden changes in humidity levels. This feature also allows the creation of genuine homemade yogurt.		

Benefit (TT)

TFT touch display

Full touch colour display for an easy and intuitive user interface

With its intuitive, full-colour interface, it offers an immediate and simple user experience, allowing programmes and functions to be selected quickly. Touch controls provide smooth and precise navigation, while the clear display of temperatures, times and settings ensures optimal control during each step of the process.

Removable temperature probe

High precision and exceptional results with the removable temperature probe, enabling perfect and controlled cooking

Insert the temperature probe to monitor the food's internal temperature for perfect results. The slow cooking function enhances flavors and tenderness while preserving essential nutrients.

Touch Guide

Enhanced ease of use, functionality and assistance thanks to the touch guide for a better display navigation

The Touch Guide provides pop-up explanations and tips when you press an icon.

Vitality System

The combined use of Smeg blast chiller, Galileo oven and vacuum drawer preserves organoleptic and nutritional qualities of food

Oven-interchangeable multifunctional grids

Maximum flexibility thanks to the oven-interchangeable grids, supporting containers and food or, when rotated, serving as a bottle holder.