

SCV115A



Family	Wine Cooler
Installation	Free standing
Defrost	Automatic
Cooling type	Fan assisted
Hinge type	Standard
Hinge position	Right



Wine cellar compartment features



Number of fixed shelves	1
Number of removable shelves	5
Number of removable and folding shelves	1
Shelves material	Wood
Adjustable shelves	Yes
Type of internal light	Led
Air filter	Activated charcoal filter

Programs/Functions



Control setting	Control buttons	Control lock	Yes
Controls	External, in the lower socket	Temperature Alarm	Yes
Display	7 digits LED	Door open alarm	Yes

Technical Features

Adjustable temperature zones	2	Refrigerant gas type	R600a
Temperature range	5-22 °C	Refrigerant Quantity (gr)	80 g
Type of temperature control	Electronic	Foam agent	Cyclopentane
Anti-UV door glass	Yes	Metal panel on the back of the fridge	Metal
		Adjustable feet	2 Front

Integrated heating element	Yes	Door opening type	With handle
Number of compressors	1		
Compressor type	Low vibration compressor		

Performance / Energy Label - Reg. 2019





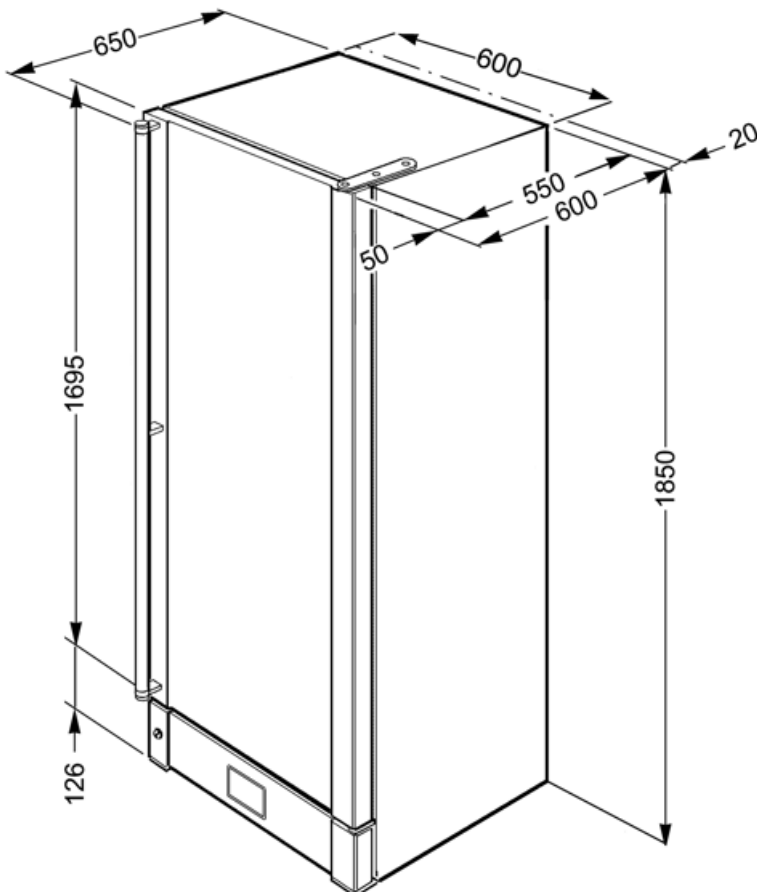

			
Max Capacity (bottles 0,75lt)	198	Sum of the volumes of the chill compartment(s) and the unfrozen compartment(s)	368 l
Annual energy consumption	181 kWh/a	Climate class	SN, N, ST
Energy efficiency class	G	EEL	179 %
Airborne acoustical noise emission class	D	Noise level	42 dB(A) re 1 pW
Total net volume	368 l		

Electrical Connection

Plug	(F;E) Schuko	Voltage (V)	220-240 V
Electrical connection rating	200 W	Frequency (Hz)	50 Hz
Current	1 A		



Symbols glossary

- | | | | | | |
|--|--|---|--|---|---|
|  | The automatic defrost system works by automatically defrosting at regular intervals eliminating the need to defrost altogether. |  | Energy efficiency class G |  | LED display: to show programmes, functions and options selected and the time to the end of the cycle. |
|  | Ventilated: Forced distribution of cold air in the refrigerator compartment, which allows even temperature distribution within the fridge. |  | Fingerprint proof stainless steel: Fingerprint proof stainless steel keeps stainless steel looking as good as new. | | |
|  | LED interior lighting: is a more energy efficient and long lasting way of illuminating the interior of the appliance. | | | | |