

SE2321TE2

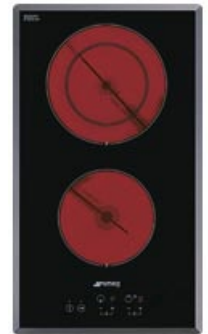

Product Family	Hob
Built-in type	Traditional
Dimensions	30 cm
Power supply	Electric
Type	Ceramic
EAN code	8017709138622



Aesthetics



Aesthetic	Universale
Colour	Black
Finishing	Glass
Material	Glass
Glass type	Ceramic
Glass edge	Angled edge
Type of control setting	Digi Touch
Control knob position	Front
Serigraphy colour	White

Program / Functions



No. of ceramic cook zones	2
No. of cooking zones with booster	2
Power levels	9
Total no. of cook zones	2

Options



Control Lock / Child Safety	Yes
-----------------------------	-----

Technical Features



Front-centre - Ceramic - Single - 1.20 kW - Ø 14.0 cm

Rear-centre - Ceramic - Double - 0.80 - 2.00 kW - Ø 11.0 - Ø 17.5 cm

Automatic switch off when overheat Yes

Residual heat indicator Yes

Automatic switch off when overflow Yes

Electrical Connection

Plug	Not present	Voltage (V)	220-240 V
Electrical connection rating (W)	3200 W	Frequency (Hz)	50/60 Hz

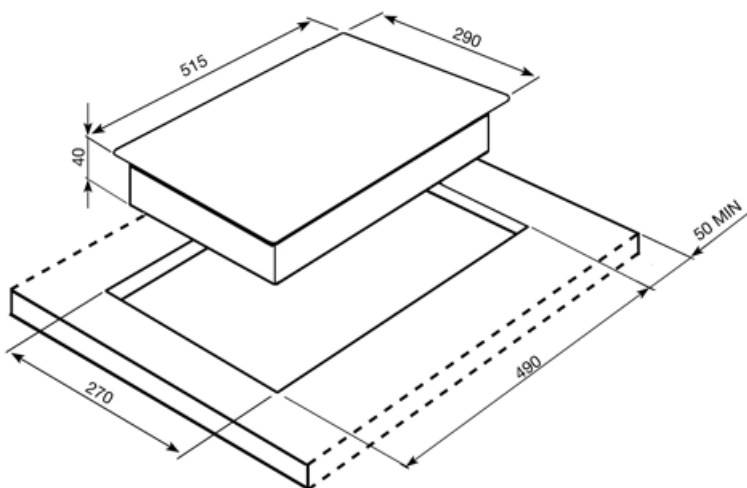









Not included accessories



SCRP

Non-scratch hob scraper - suitable for induction and ceramic hobs

Symbols glossary

	Power booster: option allows the zone to work at full power when very intense cooking is necessary.		Standard installation: Traditional installation in tabletop, suitable for any kitchen sets
	Child lock: some models are fitted with a device to lock the programme/cycle so it cannot be accidentally changed.		Overheat protection: The safety system that automatically turns off the hob in case of overheating of the control unit.
	Glass ceramic: The base of the hob is made glass ceramic. Heating is performed by the heating elements Hi-Light.		Overfill protection: The special overfill protection shuts down the stove in the presence of overflow of liquids.
	Indication of residual heat: After the glass ceramic hob is switched off the residual heat indicator shows which of the heating zones still remains hot. When the temperature drops below 60 ° C, the indicator goes out.		Touch control