

SE232TD1



Product Family	Hob
Built-in	Ultra-low profile or Fully Flushed
Dimensions	30 cm
Power supply	Electric
Type	Ceramic
EAN code	8017709312022



Aesthetics



Aesthetics	Universal
Colour	Black
Finishing	Glass
Material	Glass
Glass Type	Ceramic
Glass edge	Straight edge
Type of control setting	Touch control
Slider	Red
Control knobs position	Front
Serigraphy colour	Grey

Program / Functions

No. of ceramic cook zones	2
Main on/off switch	Yes
Power levels	9
Total no. of cook zones	2

Options



Standard cut out	490x270 mm	Show Room Demo Option	Yes
End cooking timer	2		
Minute minder	1		

Control Lock / Child Safety Yes

Technical Features



Rear centre - Ceramic - double - 1.70 kW - Ø 12.0 - Ø 18.0 cm

Front centre - Ceramic - single - 1.20 kW - Ø 14.5 cm

Automatic switch off when overheat Yes

Residual heat indicator Yes

Automatic switch off when overflow Yes

Electrical Connection

Nominal power (W)	2900 W	Frequency (Hz)	50/60 Hz
Current	13 A	Power supply cable length	130 cm
Voltage (V)	220-240 V	Terminal Box	3 poles
Type of electric cable	Single and Double phase		

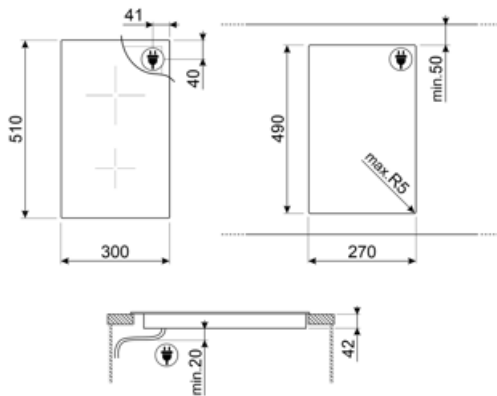







Not included accessories



SCRP

Induction and ceramic hobs and teppanyaki scraper

Symbols glossary

- | | | | |
|--|---|---|---|
|  | Child lock: some models are fitted with a device to lock the programme/cycle so it cannot be accidentally changed. |  | Touch control |
|  | Overheat protection: The safety system that automatically turns off the hob in case of overheating of the control unit. |  | Glass ceramic: The base of the hob is made glass ceramic. Heating is performed by the heating elements Hi-Light. |
|  | Overfill protection: The special overfill protection shuts down the stove in the presence of overflow of liquids. |  | Indication of residual heat: After the glass ceramic hob is switched off the residual heat indicator shows which of the heating zones still remains hot. When the temperature drops below 60 ° C, the indicator goes out. |
|  | Timer: All ceramic hobs have a timer which automatically ends cooking after a preset time. | | |