

# SE484EMTD



Product Family  
Built-in type  
Dimensions  
Power supply  
Type  
EAN code

Hob  
Ultra-low profile  
80 cm  
Electric  
Ceramic  
8017709324247



## Aesthetics



Aesthetic	Universale
Colour	Black
Finishing	Glass
Material	Glass
Glass type	Ceramic
Glass edge	Straight edge
Type of control setting	Compact Slider
LED colours	Red
Control knob position	Front
Serigraphy colour	Grey

## Programs / Functions



No. of ceramic cook zones	4
No. of cooking zones with booster	4
Main on/off switch	Yes
Power levels	9
Total no. of cook zones	4

## Options



Worktop Cut-Out 490x745 mm

<b>Keep warm automatic function</b>	Yes	<b>Limited Power Consumption Mode</b>	Yes
<b>End cooking timer</b>	4	<b>Limited Power Consumption Mode in W</b>	2800, 4000 W
<b>Minute minder</b>	1	<b>Showroom Demo Option</b>	Yes
<b>End of cooking alarm</b>	Yes	<b>Control Lock / Child Safety</b>	Yes
<b>Residual time indicator</b>	Yes	<b>Quick start</b>	Yes

## Technical Features



Front-left - Ceramic - Double - 2.30 kW - Ø 21.0 cm  
 Rear-left - Ceramic - Single - 1.20 kW - Ø 15.0 cm  
 Rear-right - Ceramic - Extendable - 2.20 kW - Ø 17.0 cm  
 Front-right - Ceramic - Single - 1.80 kW - Ø 18.5 cm

<b>Automatic switch off when overheat</b>	Yes	<b>Residual heat indicator</b>	Yes
<b>Automatic switch off when overflow</b>	Yes		

## Electrical Connection

<b>Plug</b>	Not present	<b>Type of electric cable installed</b>	Yes, Single phase
<b>Electrical connection rating (W)</b>	7400 W	<b>Additional connection modalities</b>	Yes, Double and Three Phase
<b>Current</b>	22 A	<b>Frequency (Hz)</b>	50/60 Hz
<b>Voltage (V)</b>	220-240 V	<b>Power supply cable length</b>	150 cm
<b>Voltage 2 (V)</b>	380-415 V	<b>Terminal box</b>	6 poles

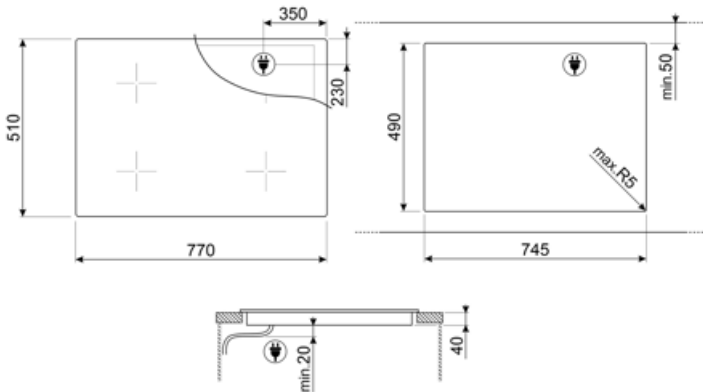

---

## Compatible Accessories













---



### SCRP

Non-scratch hob scraper - suitable for induction and ceramic hobs

## Symbols glossary

	Power booster: option allows the zone to work at full power when very intense cooking is necessary.		Ultra-low profile: Installation of product with flat edge - height of 1 mm.
	Child lock: some models are fitted with a device to lock the programme/cycle so it cannot be accidentally changed.		ECO-logic: option allows you to restrict the power limit of the appliance real energy saving.
	This function allows you to keep cooked food warm without burner it		Overheat protection: The safety system that automatically turns off the hob in case of overheating of the control unit.
	Glass ceramic: The base of the hob is made glass ceramic. Heating is performed by the heating elements Hi-Light.		Overfill protection: The special overfill protection shuts down the stove in the presence of overflow of liquids.
	Quick Start function: the chosen temperature is reached faster. The heating element works at maximum power until the right temperature is reached.		Indication of residual heat: After the glass ceramic hob is switched off the residual heat indicator shows which of the heating zones still remains hot. When the temperature drops below 60 ° C, the indicator goes out.
	Time elapsed: shows how long the cooking zone has been in use.		Timer: All ceramic hobs have a timer which automatically ends cooking after a preset time.
	Compact Slider intuitive and easy to use		