

SF6400PZX



Category	60cm
Product Family	Oven
Power supply	Electric
Heat source	ELECTRICITY
Cooking method	Thermo-ventilated
Cleaning system	Ever Clean enamel
Pizza Oven	Yes
EAN code	8017709324995



Aesthetics

Aesthetic	Selezione	Serigraphy type	Symbols
Colour	Stainless steel	Door	With panel
Finishing	Fingerproof	Handle	Selection squared
Design	Flat	Handle Colour	Steel effect
Material	Stainless steel	Logo	Embossed
Type of steel	Brushed	Control knobs	Cucina restyling
Glass Type	Eclipse	Controls colour	Steel effect
Serigraphy colour	Black		

Controls

Display name	DigiScreen	Control setting	Knobs & touch buttons
Display technology	LED	No. of controls	2

Programs / Functions main oven

No. of cooking functions 8

Traditional cooking functions

Static	Fan assisted	Circulaire
Eco	Large grill	Fan grill (large)
Fan assisted base	Pizza	

Other functions

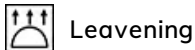

Options



Time-setting options Automatic end cooking
Minute minder Yes

Timer 1
Rapid pre-heating Yes

Technical Features



Minimum Temperature 50 °C
Maximum temperature 250 °C
No. of shelves 5
N. of fans 1
No. of lights 1
Light type Halogen
User-replaceable light Yes
Light Power 40 W
Lower heating element power 1100 W
Upper heating element - Power 1000 W
Grill element - power 1700 W
Large grill - Power 2700 W
Circular heating element - Power 2000 W

Door Fresh Touch
Removable door Yes
Full glass inner door Yes
Removable inner door Yes
Total no. of door glasses 3
Chimney Fixed
Cooling system Tangential
Cooling duct Double
Speed Reduction Cooling System Yes
Usable cavity space dimensions (HxWxD) 331x460x412 mm
Temperature control Electro-mechanical
Cavity material Ever clean Enamel

Performance / Energy Label



Energy efficiency class A
Net volume of the cavity 65 l
Energy consumption per cycle in conventional mode 1.09 kWh
Energy consumption in conventional mode 3.92 MJ

Energy consumption in forced air convection 2.81 MJ
Energy consumption per cycle in fan-forced convection 0.78 kWh
Number of cavities 1
Energy efficiency index 95,1 %

Accessories Included

Rack with back stop 1
Enamelled deep tray (40mm) 1

Pizza Accessories Refractory stone (round without handles) + cover

Electrical Connection

Plug	Not present	Nominal power	3000 W
Voltage	220-240 V	Frequency (Hz)	50/60 Hz
Current	13 A	Power supply cable length	150 cm

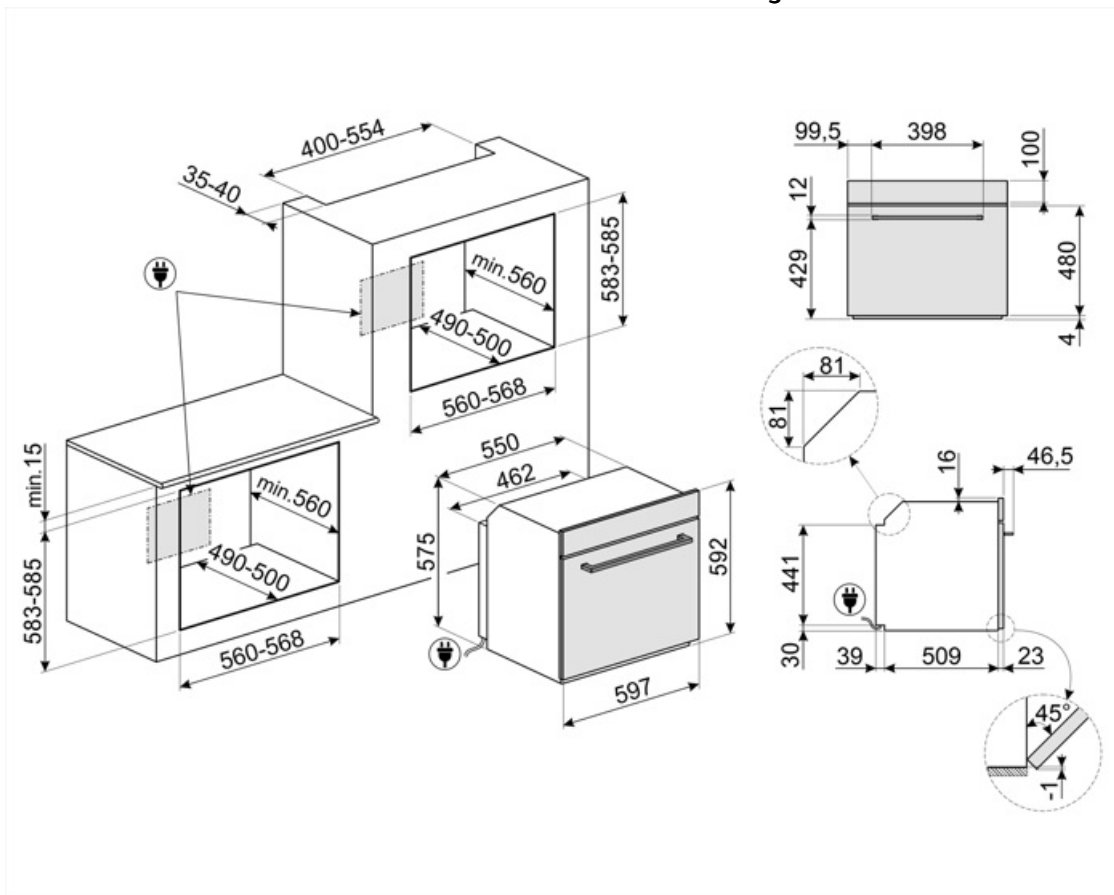

Compatible Accessories



BN620-1

Enamelled tray suitable for 45cm and 60cm ovens. Depth 20 mm. Perfect for a wide range of savoury and sweet baking.

GTP



Partially extractable telescopic guides (1 level), suitable for traditional ovens. Made in stainless steel, they guarantee stability and facilitate the smooth extraction of the trays.

PALPZ



Pizza shovel with folding handle. Dimensions L31.5 x H32.5 cm. Easy and convenient to use and store. Perfect for serving pizza, bread and savory pastries in a safe and professional way.



BN640

Enamelled tray suitable for 45cm and 60cm ovens. Depth 540 mm. Perfect for cooking and roasting meat and fish in sauces. Also ideal for experimenting with lighter and crunchy side dishes

GTT



















Totally extractable telescopic guides (1 level), suitable for traditional ovens. Made in stainless steel, they guarantee stability and facilitate the smooth extraction of the trays.

PR3845X



Antifingerprint stainless steel. Cover for furniture in column installation of more ovens

Symbols glossary

			Air cooling system: to ensure a safe surface temperatures.
	Triple glazed doors: Number of glazed doors.		Electric
	Ever Clean Enamel: Ever Clean enamel is applied electrostatically, corner to corner and edge to edge to prevent cracking or cracks over time. It is a particular pyrolytic enamel, resistant to acids which, in addition to being pleasantly bright, promotes greater cleaning of the oven walls, thanks to its lower porosity. It is baked at over 850 ° C and slowly polymerized at a scientifically determined rate to ensure uniform depth and strength Ever Clean enamel creates an impeccable finish both on the inside of the oven and on the trays, making the surfaces of the oven incredibly easy to maintain over time as it reduces the adhesion of fat during cooking		Fresh Touch: Most of Smeg ovens have a "cool door." Thanks to the combination of tangential cooling and internal heat-reflecting glasses, the temperature on the outer surface of the door is maintained below 50° C. In addition to providing safety, this system protects the sides of the furniture from overheating by the oven.
	Fan assisted base: the mix of fan and lower heating element alone allows to finish cooking foods already cooked on the surface but not internally more quickly. This system is recommended to finish cooking foods that are already well cooked on the surface, but not internally, which therefore require a moderate higher heat. Ideal for any type of food.		Fan assisted: Intense and homogeneous traditional cooking, also suitable for complex recipes. The fan is active and the heat comes from below and from above at the same time. Ventilated cooking ensures a faster and more homogeneous result, leaving fragrant foods outside and moister inside. Ideal for baked pasta, biscuits, roasts and cobblers.
	Static: Traditional cooking suitable for the preparation of one dish at a time. The fan is not active and the heat comes from below and from above at the same time. Static cooking is slower and more delicate, ideal in order to get well cooked and dry dishes even inside. Ideal for cooking all types of roasts, fatty meats, bread, filled cakes.		Circulaire: it is the perfect function for cooking all types of dishes in a more delicate way. The heat comes from the back of the oven and is distributed quickly and evenly The fan is active. It is also ideal for cooking on multiple levels without mixing smells and flavors.
	ECO: low energy consumption cooking: this function is particularly suitable for cooking on a single shelf with low energy consumption. It is recommended for all types of food except those that can generate a lot of moisture (for example vegetables). To achieve maximum energy savings and reduce time, it is recommended to put the food in the oven without preheating the cooking compartment		Grill: Very intense heat coming only from above from a double heating element. The fan is not active. Provides excellent grilling and gratinating results. Used at the end of cooking, it gives a uniform browning to dishes.
	Fan grill: very intense heat coming only from above from a double heating element The fan is active. It allows the optimal grilling of thickest meats. Ideal for large cuts of meat.		Pizza function: Specific function for cooking pizza in a pan. It allows to obtain a pizza that is soft inside and crispy outside with the topping perfectly cooked, not dry and not burnt.
	All glass inner door: All glass inner door, a single flat surface which is simple to keep clean.		The inner door glass: can be removed with a few quick movements for cleaning.



Side lights: Two opposing side lights increase visibility inside the oven.



Pizza function: Some ovens have an exclusive "Pizza" function which provides direct contact of the refractory stone for cooking pizza with low heating element. This allows cooking pizza in just 3 - 5 minutes, depending on the filling. This function is also ideal for cooking pies, baked fish and vegetables.



Air at 40°C provides the perfect environment for proving yeast type dough mixes. Simply select the function and place dough in the cavity for allotted



Rapid preheating: cooking is preceded by the preheating phase which allows the cooking compartment to reach the set temperature. This option reduces the time by up to 50%.



The oven cavity has 5 different cooking levels.



The capacity indicates the amount of usable space in the oven cavity in litres.



The capacity indicates the amount of usable space in the oven cavity in litres.



4.3 inch display with LED technology, usability with knobs + 3 touch keys