

SFP6401TVX1



Categorie	60 cm
Product familie	Oven
Stroomvoorziening	Elektrisch
Warmtebron	Elektriciteit
Bereidingswijze	Multifunctionele oven
Reinigingssysteem	Pyrolyse reiniging
EAN-code	8017709285449



Design

Design	Elementi	Type zeefdruk	Symbolen
Kleur	Inox	Deur	Met paneel
Afwerking	Fingerproof	Handvat	Elementi/ Selezione
Design	Plat		Squadrata
Materiaal	Inox	Kleur handvat	Inox look
Type roestvrijstaal	Geborsteld inox	Logo	In reliëf
Type glas	Eclipse zwart glas	Bedieningsknoppen	Elementi
Kleur serigrafie	Zwart	Kleur bedieningsknoppen	Inox look

Bediening

			
Display	CompactScreen	Bediening	Bedieningsknoppen
Display	LCD	Aantal bedieningsknoppen	2

Programma's / Functies

Aantal kookfuncties	10
Automatische programma's	No
Individualiseerbare recepten	No

Traditionele bereidingsfuncties

Statisch	Statisch + ventilator	Circulatie (ventilator + circulaire)
Turbo: ventilator + circulaire + statisch	ECO	Grote grill
Ventilator + grote grill	Onderwarmte	Circulaire + onderwarmte
Pizza		

Overige functies

Ontdooien op tijd	Rijzen	Sabbath
-------------------	--------	---------

Reinigingsfuncties

Pyrolyse

Opties



Tijdsinstelling	Automatische in- en uitschakeling	Andere opties	Warmhoudfunctie
Timer	Ja	Showroom demo optie	Ja
Timer	1	Snel voorverwarmen	Ja
Kinderbeveiliging	Ja		

Technische specificaties



Minimum temperatuur	30 °C	Opening deur	Standaard opening
Maximum temperatuur	280 °C	Deur	Koud
Aantal kookniveaus	5	Uitneembare ovendeur	Ja
Dubbele ventilator	1	Volledig glazen binnendeur	Ja
Aantal lampen	1	Uitneembaar glas binnendeur	Ja
Type lamp	Halogeen	Totaal aantal ruiten	4
User-replaceable light	Ja	Koelsysteem	Mantelkoeling
Vermogen lamp	40 W	Koelleiding	Dubbel
Verlichting bij opening deur	Ja		

Onderwarmte - vermogen	1200 W	Reductie snelheid koelsysteem	Ja
Grill - vermogen	1800 W	Deurblokkering tijdens pyrolyse	Ja
Circulatie - vermogen	2000 W	Afmetingen bruikbare interne ovenruimte (hxbxd)	360x460x425 mm
Warmte onderbroken bij openen deur	Ja	Temperatuurcontrole	Elektronisch
		Materiaal ovenruimte	Ever Clean emaille

Prestaties / energielabel



Energie-efficiëntieklasse	A+	Energy consumption in forced air convection	2.45 MJ
Netto volume	70 l	Energieconsumptie in turbo functie	0.68 kWh
Energieconsumptie in conventionele functie	1.09 kWh	Aantal ovens	1
Energy consumption in conventional mode	3.92 MJ	Energie-efficiëntie Index	81 %

Meegeleverde accessoires

Ovenrooster met stop	1	Inzetrooster	1
Bakplaat (40 mm)	1		

Elektrische aansluiting

Spanning	220-240 V	Frequentie	50/60 Hz
Stroom	13 A	Lengte voedingskabel	150 cm
Nominale aansluitwaarde	3000 W		

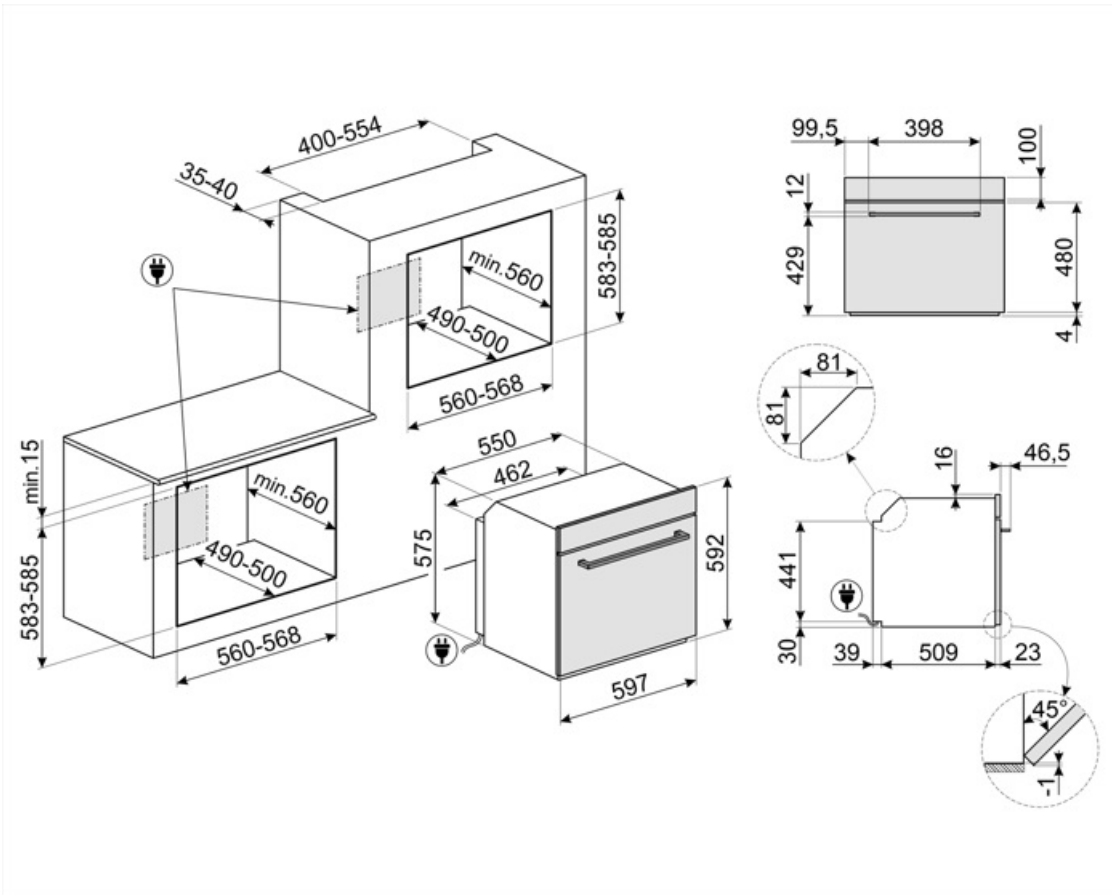

Not included accessories



BN620-1

Enamelled tray suitable for 45cm and 60cm ovens. Depth 20 mm. Perfect for a wide range of savoury and sweet baking.

GTP



Partially extractable telescopic guides (1 level), suitable for traditional ovens. Made in stainless steel, they guarantee stability and facilitate the smooth extraction of the trays.

PALPZ



Pizzapallet inox met ploibaar handvat, 315x325 mm



BN640

Enamelled tray suitable for 45cm and 60cm ovens. Depth 540 mm. Perfect for cooking and roasting meat and fish in sauces. Also ideal for experimenting with lighter and crunchy side dishes

GTT

















Volledig uitschuifbare telescopische rails (1 niveau) voor traditionele ovens (SF-).



















PR3845X



Inox profiel voor installatie ovens in kolom

Symbols glossary

 <p>Sommige modellen zijn voorzien van een functie om het programma/de cyclus te blokkeren zodat het niet per ongeluk kan aangepast worden.</p>	 <p>A+: Energy efficiency class A+ helps to save up to 10% energy compared to class A. Maximum performance with minimum consumption is guaranteed.</p>
 <p>Air cooling system: to ensure a safe surface temperatures.</p>	 <p>Defrost by time: Manual defrost function. At the end of the set duration, the function stops.</p>
 <p>COMPACTscreen display + bedieningsknoppen</p>	 <p>Quadruple glazed: Number of glazed doors.</p>
 <p>Elektrische aansluiting</p>	 <p>Ever Clean Enamel: Ever Clean enamel is applied electrostatically, corner to corner and edge to edge to prevent cracking or cracks over time. It is a particular pyrolytic enamel, resistant to acids which, in addition to being pleasantly bright, promotes greater cleaning of the oven walls, thanks to its lower porosity. It is baked at over 850 ° C and slowly polymerized at a scientifically determined rate to ensure uniform depth and strength Ever Clean enamel creates an impeccable finish both on the inside of the oven and on the trays, making the surfaces of the oven incredibly easy to maintain over time as it reduces the adhesion of fat during cooking</p>
 <p>Fingerprint proof stainless steel: Fingerprint proof stainless steel keeps stainless steel looking as good as new.</p>	 <p>Fresh Touch: Most of Smeg ovens have a "cool door." Thanks to the combination of tangential cooling and internal heat-reflecting glasses, the temperature on the outer surface of the door is maintained below 50° C. In addition to providing safety, this system protects the sides of the furniture from overheating by the oven.</p>
 <p>Ventilator met bovenste en onderste elementen: De elementen in combinatie met de ventilator zijn bedoeld om een meer gelijkmatige warmte te bieden, een methode die vergelijkbaar is met conventioneel koken, dus voorverwarmen is vereist. Het meest geschikt voor items die langzaam koken vereisen.</p>	 <p>Alleen boven- en onder element: een traditionele kookmethode die het meest geschikt is voor losse items in het midden van de oven. de bovenkant van de oven zal altijd het heetst zijn. Ideaal voor gebraden vlees, fruitcake, brood etc.</p>
 <p>Base: the heat comes only from the bottom of the cavity. The fan is not active. Ideal for sweet and savory pies, cobbles and pizzas. Designed to complete cooking and make food more crunchy This symbol in gas ovens indicates the gas burner.</p>	 <p>Circulaire met onderste element: De toevoeging van het onderste element voegt extra warmte toe aan de basis voor voedsel dat extra moet worden gekookt.</p>

-  **Circulaire:** De combinatie van de ventilator en het ronde element eromheen zorgt voor een hete lucht kookmethode. Dit biedt vele voordelen, waaronder geen voorverwarmen als de kooktijd meer dan 20 minuten bedraagt, geen smaakoverdracht bij het gelijktijdig bereiden van verschillende soorten voedsel, minder energie en kortere kooktijden. Geschikt voor alle soorten voedsel.
-  **Grill:** Very intense heat coming only from above from a double heating element. The fan is not active. Provides excellent grilling and gratinating results. Used at the end of cooking, it gives a uniform browning to dishes.
-  **Pizza function:** Specific function for cooking pizza in a pan. It allows to obtain a pizza that is soft inside and crispy outside with the topping perfectly cooked, not dry and not burnt.
-  **All glass inner door:** All glass inner door, a single flat surface which is simple to keep clean.
-  **Met deze functie kan u bereidingen warmhouden zodat het eten niet meteen afkoelt**
-  **PYROLYSIS - AUTOMATIC CLEANING FUNCTION:** the oven heats up to a temperature approaching 500 ° C and chars grease and food residues into a fine ash that can be easily wiped off with a damp cloth. At such a high temperature, the door locks automatically for safety, while the temperature of the door remains controlled so it is safe to touch User adjustable function based on the level of dirt present in the oven.
-  **Rapid preheating:** cooking is preceded by the preheating phase which allows the cooking compartment to reach the set temperature. This option reduces the time by up to 50%.
-  **The oven cavity has 5 different cooking levels.**
-  **The capacity indicates the amount of usable space in the oven cavity in litres.**
-  **De combinatie van de grill, de ventilator en onderwarmte is interessant voor het bereiden van kleine hoeveelheden.**
-  **Fan grill:** very intense heat coming only from above from a double heating element The fan is active. It allows the optimal grilling of thickest meats. Ideal for large cuts of meat.
-  **Circulaire met bovenste en onderste elementen:** door het gebruik van de ventilator met beide elementen kan voedsel snel en effectief worden gekookt, ideaal voor grote stukken vlees die grondig moeten worden gekookt. Het biedt een vergelijkbaar resultaat als rotisserie, waarbij de warmte rond het voedsel wordt verplaatst in plaats van het voedsel zelf te verplaatsen, waardoor elke maat of vorm kan worden gekookt.
-  **The inner door glass:** can be removed with a few quick movements for cleaning.
-  **Side lights:** Two opposing side lights increase visibility inside the oven.
-  **Air at 40°C provides the perfect environment for proving yeast type dough mixes. Simply select the function and place dough in the cavity for allotted**
-  **SABBATH:** function that allows to cook food respecting Judaism's day of rest provisions.
-  **Electronic control:** Allows you to maintain temperature inside the oven with the precision 2-3 ° C. This enables to cook meals that are very sensitive to temperature changes, such as cakes, souffles, puddings.
-  **The capacity indicates the amount of usable space in the oven cavity in litres.**