

# SO4101M1B3

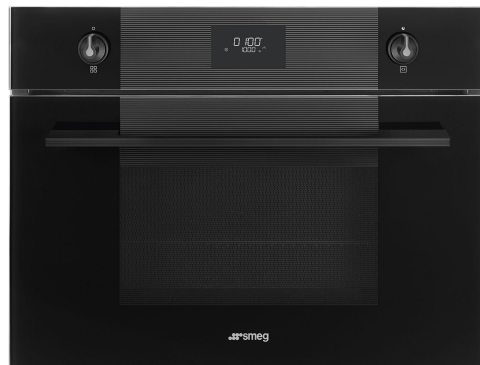

Categorie	45 cm
Product familie	Oven
Stroomvoorziening	Elektrisch
Warmtebron	Elektriciteit
Bereidingswijze	Combi-microgolf
Galileo technologie	Micro combi
EAN-code	8017709337292



## Design

Design	Linea	Type zeefdruk	Symbolen
Kleur	Zwart	Deur	Geheel glas
Afwerking	Glanzend	Handvat	Linea minimal
Design	Plat	Kleur handvat	Zwart
Materiaal	Glas	Logo	Geëts
Type glas	Clear1	Bedieningsknoppen	Linea
Kleur serigrafie	Grijs	Kleur bedieningsknoppen	Zwart







## Bediening

			
Display	CompactScreen	Bediening	Bedieningsknoppen
Display	LCD	Aantal bedieningsknoppen	2





## Programma's / Functies

Aantal kookfuncties	10
Individualiseerbare recepten	No

## Traditionele bereidingsfuncties

 Statisch	 Statisch + ventilator	 Circulatie (ventilator + circulaire)
 Turbo: ventilator + circulaire + statisch	 ECO	 Grote grill

## Bereidingsfuncties met microgolven

 Microgolfoven	 Microgolf + boven- en onderwarmte + ventilator	 Microgolf + circulaire + ventilator
 Microgolf + grill		

## Overige functies

 Ontdooien op tijd
--

## Opties



<b>Tijdsinstelling</b>	Automatische in- en uitschakeling	<b>Andere opties</b>	Warmhoudfunctie, Eco light
Timer	Ja	<b>Showroom demo optie</b>	Ja
Timer	1	<b>Snel voorverwarmen</b>	Ja
Kinderbeveiliging	Ja		

## Technische specificaties



<b>Minimum temperatuur</b>	30 °C	<b>Opening deur</b>	Standaard opening
<b>Maximum temperatuur</b>	280 °C	<b>Deur</b>	Temperatuur gecontroleerde deur
<b>Aantal kookniveaus</b>	2	<b>Totaal aantal ruiten</b>	3
<b>Aantal lampen</b>	1	<b>Automatische uitschakeling microgolf bij openen deur</b>	Ja
<b>Type lamp</b>	Halogeen	<b>Chimney</b>	Fixed
<b>Vermogen lamp</b>	40 W	<b>Koelsysteem</b>	Mantelkoeling
<b>Verlichting bij opening deur</b>	Ja	<b>Koelleiding</b>	Enkel
<b>Onderwarmte - vermogen</b>	1000 W		
<b>Grill - vermogen</b>	1750 W		

Circulatie - vermogen 1400 W  
 Warmte onderbroken bij  
 openen deur ja

Afmetingen bruikbare  
 interne ovenruimte  
 (hxbxd) 211x462x401 mm  
 Temperatuurcontrole Elektronisch  
 Materiaal ovenruimte Ever Clean emaille  
 Veiligheidsscherm Ja  
 microgolfd deur

## Prestaties / energielabel



Netto volume 40 l  
 Aantal ovens 1

Effectief vermogen 850 W  
 microgolfd

## Meegeleverde accessoires

Ovenrooster met stop 1  
 Inzetrooster 1

Glazen ovenplaat 1







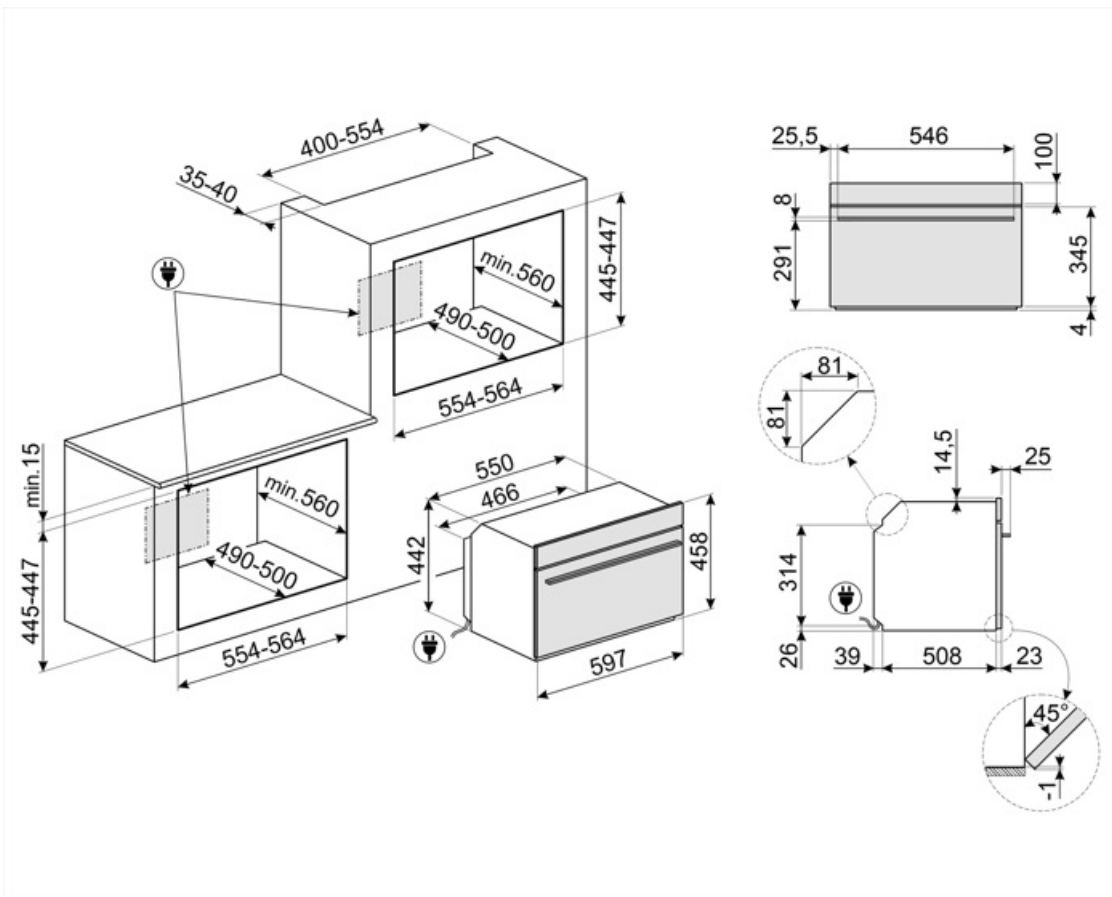







## Elektrische aansluiting















Spanning 220-240 V  
 Stroom 14 A  
 Nominale  
 aansluitwaarde 3100 W

Frequentie 50 Hz  
 Lengte voedingskabel 150 cm



## Symbols glossary

 <p>Sommige modellen zijn voorzien van een functie om het programma/de cyclus te blokkeren zodat het niet per ongeluk kan aangepast worden.</p>	 <p>Combination microwave: This oven allows to combine two different ways of cooking (Traditional with microwaves). Combined ovens increase cooking opportunities, while providing maximum flexibility of household appliances.</p>
 <p>Air cooling system: to ensure a safe surface temperatures.</p>	 <p>Defrost by time: Manual defrost function. At the end of the set duration, the function stops.</p>
 <p>COMPACT screen display + bedieningsknoppen</p>	 <p>Triple glazed doors: Number of glazed doors.</p>
 <p>Automatic lighting deactivation: For greater energy savings, the lighting turns off automatically after one minute from the start of cooking. The option can be disabled via the settings menu. In this case the light will remain on for the entire duration of cooking.</p>	 <p>Elektrische aansluiting</p>
 <p>Ever Clean Enamel: Ever Clean enamel is applied electrostatically, corner to corner and edge to edge to prevent cracking or cracks over time. It is a particular pyrolytic enamel, resistant to acids which, in addition to being pleasantly bright, promotes greater cleaning of the oven walls, thanks to its lower porosity. It is baked at over 850 ° C and slowly polymerized at a scientifically determined rate to ensure uniform depth and strength. Ever Clean enamel creates an impeccable finish both on the inside of the oven and on the trays, making the surfaces of the oven incredibly easy to maintain over time as it reduces the adhesion of fat during cooking.</p>	 <p>Ventilator met bovenste en onderste elementen: De elementen in combinatie met de ventilator zijn bedoeld om een meer gelijkmatige warmte te bieden, een methode die vergelijkbaar is met conventioneel koken, dus voorverwarmen is vereist. Het meest geschikt voor items die langzaam koken vereisen.</p>
 <p>Alleen boven- en onder element: een traditionele kookmethode die het meest geschikt is voor losse items in het midden van de oven. de bovenkant van de oven zal altijd het heetst zijn. Ideaal voor gebraden vlees, fruitcake, brood etc.</p>	 <p>Circulaire: De combinatie van de ventilator en het ronde element eromheen zorgt voor een hete lucht kookmethode. Dit biedt vele voordelen, waaronder geen voorverwarmen als de kooktijd meer dan 20 minuten bedraagt, geen smaakoverdracht bij het gelijktijdig bereiden van verschillende soorten voedsel, minder energie en kortere kooktijden. Geschikt voor alle soorten voedsel.</p>
 <p>De combinatie van de grill, de ventilator en onderwarmte is interessant voor het bereiden van kleine hoeveelheden.</p>	 <p>Grill: Very intense heat coming only from above from a double heating element. The fan is not active. Provides excellent grilling and gratinating results. Used at the end of cooking, it gives a uniform browning to dishes.</p>

-  Microwave: Penetrating straight into the food, microwaves cook very quickly and with considerable energy savings. Suitable for cooking without fat, they are also able to thaw and heat food without altering its original appearance and aroma. The microwave function can also be combined with conventional functions with all the resulting advantages. Ideal for all types of food.
-  Microwave + grill element: The use of the grill results in a perfect browning of the surface of the food. The action of microwaves allows instead of cooking in a short time the internal part of the food.
-  Circulaire met bovenste en onderste elementen: door het gebruik van de ventilator met beide elementen kan voedsel snel en effectief worden gekookt, ideaal voor grote stukken vlees die grondig moeten worden gekookt. Het biedt een vergelijkbaar resultaat als rotisserie, waarbij de warmte rond het voedsel wordt verplaatst in plaats van het voedsel zelf te verplaatsen, waardoor elke maat of vorm kan worden gekookt.
-  Met deze functie kan u bereidingen warmhouden zodat het eten niet meteen afkoelt
-  Side lights: Two opposing side lights increase visibility inside the oven.
-  The oven cavity has 2 different cooking levels.
-  Tilting grill: the tilting grill can be easily unhooked to move the heating element and clean the roof of the appliance in one simple step.
-  The capacity indicates the amount of usable space in the oven cavity in litres.
-  Cooking with the simultaneous use of the heating element in combination with fan and microwave supply.
-  Fan combined with traditional cooking, where heat is generated from above and below, provides uniform heat. Adding the microwave function allows the same cooking results in less time.
-  Compacte toestellen met een hoogte van 45 cm - perfecte oplossing om te voldoen aan de functionele eisen van keukensets met een kleine hoogte. Verkrijgbaar in verschillende soorten en in verschillende stijlen.
-  Illuminated controls: are a safety device to alert the user that the appliance is on as well as being a stunning design feature.
-  Rapid preheating: cooking is preceded by the preheating phase which allows the cooking compartment to reach the set temperature. This option reduces the time by up to 50%.
-  Electronic control: Allows you to maintain temperature inside the oven with the precision 2-3 ° C. This enables to cook meals that are very sensitive to temperature changes, such as cakes, souffles, puddings.
-  The capacity indicates the amount of usable space in the oven cavity in litres.