

SO5100TB3

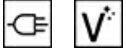

Category	75cm Single Ovens
Product Family	Oven
Power supply	Electric
Heat source	Electric
Cooking method	Thermo-ventilated
Cleaning system	Vapor Clean
EAN code	8017709327125



Aesthetics

Aesthetics	Linea	Door	Full glass
Colour	Black	Handle	Linea minimal
Design	Flat	Handle Colour	Black
Material	Glass	Logo	Silk screen
Glass Type	Clear1	Control knobs	Linea
Serigraphy colour	Grey	Controls colour	Matt black
Serigraphy type	Symbols		

Controls

			
Display name	DigiScreen	Control setting	Knobs & touch buttons
Display technology	LED	No. of controls	2

Programs / Functions

No. of cooking functions	8
--------------------------	---

Traditional cooking functions



Static



Fan assisted



Circulaire



Turbo (circulaire + bottom + upper +



ECO



Large grill

fan)



Fan grill (large)



Base

Other functions



Defrost by time

Cleaning functions



Vapor Clean

Options

Time-setting options	Delay start and automatic end cooking	Timer	1
Minute minder	Yes		

Technical Features



Minimum Temperature	30 °C	Heating suspended when door is opened	Yes
Maximum temperature	260 °C	Door opening type	Standard opening
Shelf positions	4	Door	Temperate door
No. of lights	1	Removable door	Yes
Light type	Halogen	Full glass inner door	Yes
User-replaceable light	Yes	Removable inner door	Yes
Light power	40 W	Total no. of door glasses	3
Light when door is opened	Yes	Cooling system	Tangential
Lower heating element power	1600 W	Cooling duct	Double
Upper heating element - Power	1200 W	Speed Reduction Cooling System	Yes
Grill element - power	1500 W	Usable cavity space dimensions (HxWxD)	312x613x402 mm
Large grill - Power	2700 W	Temperature control	Electronic

Circular heating element 2000 W
- Power

Cavity material

Easy clean enamel

Performance / Energy Label



Energy efficiency class A+
Net volume of the cavity 77 litres
Energy consumption per cycle in conventional mode 1.24 kWh
Energy consumption in conventional mode 4.46 MJ

Energy consumption in forced air convection 2.56 MJ
Energy consumption per cycle in fan-forced convection 0.71 kWh
Number of cavities 1
Energy efficiency index 81,6 %

Accessories Included

Chrome shelf 1

Extra deep enamelled tray (40mm) 1

Electrical Connection

Voltage 220-240 V
Current 14 A
Nominal power (W) 3100 W

Frequency (Hz) 50/60 Hz
Power supply cable length 150 cm

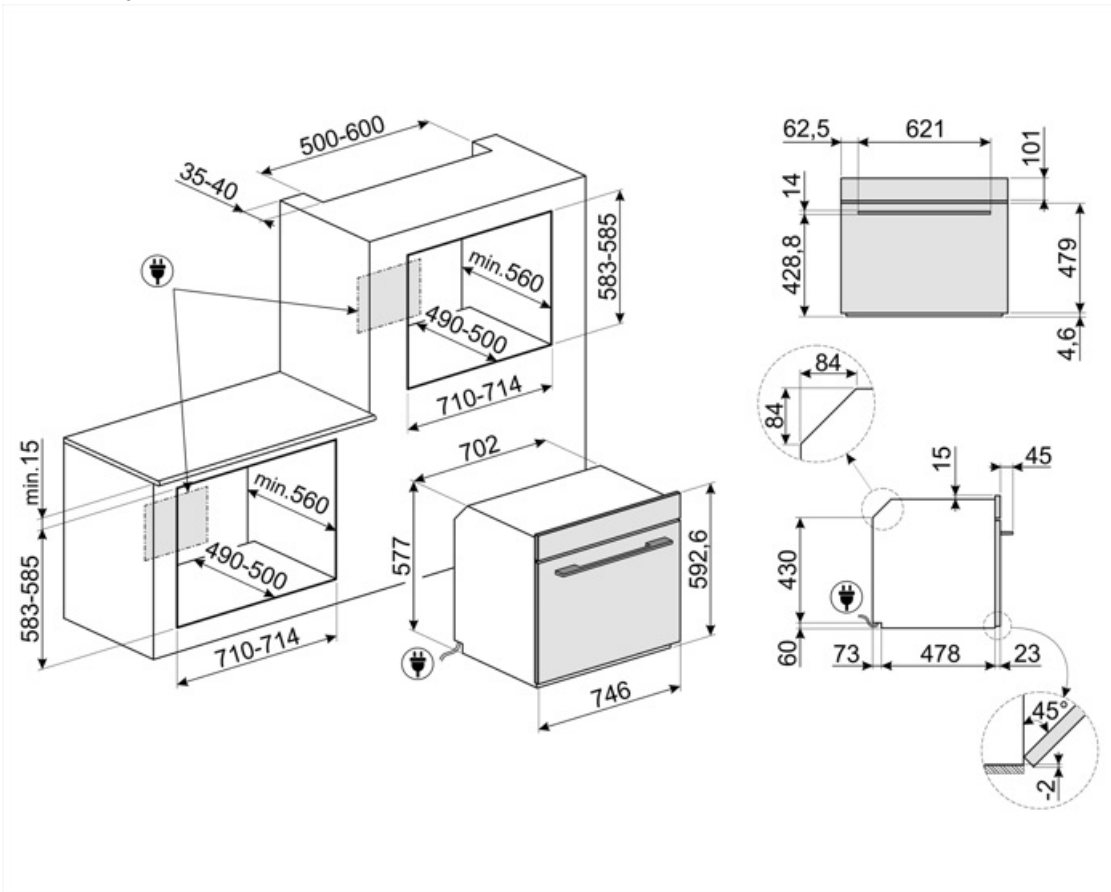



















Not included accessories

STONE

Rectangular refractory stone. Ideal for cooking pizzas with the same results as a typical wood-fired oven. Can also be used for baking bread, focaccias and other recipes such as pies, flans or biscuits Dimensions: L42 x H1,8 x P37,5 cm.



Symbols glossary

 <p>A+: Energy efficiency class A+ helps to save up to 10% energy compared to class A. Maximum performance with minimum consumption is guaranteed.</p>	 <p>Air cooling system: to ensure a safe surface temperatures.</p>
 <p>Defrost by time: with this function the time of thawing of foods are determined automatically.</p>	 <p>The touch timer display or DigiScreen guarantees simple functionality. They display the time, set programmed cooking and the minute minder timer.</p>
 <p>Triple glazed doors: Number of glazed doors.</p>	 <p>Electric</p>
 <p>Enamel interior: The enamel interior of all Smeg ovens have a special antacid lining which helps keep the interior clean by reducing the amount of cooking grease adhering to it.</p>	 <p>Fan with upper and lower elements: The elements combined with the fan aim to provide more uniform heat, a similar method to conventional cooking, so pre-heat is required. Most suitable for items requiring slow cooking methods.</p>
 <p>Upper and lower element only: a traditional cooking method best suited for single items located in the centre of the oven. the top pf the oven will always be hottest. Ideal for roast, fruit cakes, bread etc.</p>	 <p>Lower heating element only: This function is ideal for foods that require extra base temperature without browning, e.g. pastry dishes, pizza. Also suitable for slow cooking of stews and casseroles.</p>
 <p>Circulaire: The combination of the fan and circular element around it gives a hot air cooking method. This provides many benefits including no preheat if cook time is more than 20 minutes, no flavour transfer when cooking different foods at the same time, less energy, and shorter cook times. Good for all types of food.</p>	 <p>ECO: The combination of the grill, fan and lower element is particularly suitable for cooking small quantities of food.</p>
 <p>Grill element: Using of grill gives excellent results when cooking meat of medium and small portions, especially when combined with a rotisserie (where possible). Also ideal for cooking sausages and bacon.</p>	 <p>Fan with grill element: The fan reduces the fierce heat from the grill, providing an excellent method of grilling various foods, chops, steaks, sausages etc. giving even browning and heat distribution, without drying out the food. The top two levels recommended for use, and the lower part of the oven can be used to keep items warm at the same time, an excellent facility when cooking a grilled breakfast. Half grill (centre portion only) is ideal for small quantities of food.</p>
 <p>Circulaire with upper and lower elements: The use of the fan with both elements allows food to be cooked quickly and effectively, ideal for large joints that require thorough cooking. It offers a similar result to rotisserie, moving the heat around the food, instead of moving the food itself, enabling any size or shape to be cooked.</p>	 <p>All glass inner door: All glass inner door, a single flat surface which is simple to keep clean.</p>
 <p>The inner door glass: can be removed with a few quick movements for cleaning.</p>	 <p>Side lights: Two opposing side lights increase visibility inside the oven.</p>



The oven cavity has 4 different cooking levels.



Electronic control: Allows you to maintain temperature inside the oven with the precision 2-3 ° C. This enables to cook meals that are very sensitive to temperature changes, such as cakes, souffles, puddings.



Vapor Clean: a simple cleaning function using steam to loosen deposits in the oven cavity.



The capacity indicates the amount of usable space in the oven cavity in litres.



The capacity indicates the amount of usable space in the oven cavity in litres.