

SO6604M2PNR



Categorie	60 cm
Familie	Oven
Voeding	Elektrisch
Bereidingswijze	Combi-magnetron
Technologie	SpeedwaveXL
Reinigingssysteem	Vapor Clean
EAN-code	8017709345549



Design

Esthetiek	Dolce Stil Novo	Type glas	Zwart
Kleur	Zwart	Deur	Geheel glas
Afwerking	Glanzend	Handgreep	Dolce Stil Novo
Design	Plat	Kleur handgreep	Zwart
Afwerking componenten	Koper	Logo	Geassembleerd
Materiaal	Glas		

Bediening



Naam display	VivoScreen	Aantal weergaven talen	20
Display technologie	TFT	Weergave taal	Italiano, English (UK), Français (FR), Français (CA), Nederlands, Español (ES), Español (MX), Português (PT), Svenska, Русский, Deutsch (DE), Dansk, Norsk, Polski, English (AU), Suomi, Ukrainian, Kazakh, Afrikaans (ZA), Zulu (ZA)
Regeling bediening	Touch control		

Programma's / functies

Aantal kookfuncties	20
Automatische programma's	150
Personaliseerbare recepten	10

Traditionele kookfuncties

Statisch	Geventileerd	Circulaire
Turbohitte	ECO	Grote vlak-grill
Fan grill (large)	Base	Circulaire + bottom
Pizza		

Bereidingsfuncties met microgolven

Magnetron	Geventileerd	Circulaire
Microwave + grill	Microwavews + Circulaire + bottom	Opwarmen en regenereren

Overige functies

Ontdooien op tijd	Ontdooien op gewicht	Rijsfunctie
Stone cooking	BBQ	Air-Fry
Melt	Soft	Pop-corn
Warmhoudfunctie	Bordenwarmfunctie	Sabbath

Schoonmaak functie

Vapor Clean

Opties



Opties	Automatische in- en uitschakeling	Same Time cooking	Ja
tijdprogrammering		DeltaT cooking	Ja
Timer	Ja	Showroom demo optie	Ja
Timer	D	Begeleide demo functie	Ja
Kinderbeveiliging	Ja	Snelgids	Ja
Overige opties	Warmhoudfunctie, ECO-Light, Taalinstelling, Weergave digitale klok, ECO-Logic, Helderheid, Tonen, Tones volume	Geheugen	Ja, de 10 laatst gebruikte functies
Koken met kerntemperatuurmeter	Ja	Snelle voorverwarming	Ja
Bakken in fases	Ja, tot 2 stappen	Instant GO	Ja
Smart cooking	Ja		

Technische specificaties



Minimum temperatuur	30 °C	Deur	Koud
Maximum temperatuur	250 °C	Volledig glazen binnendeur	Ja
Aantal kookniveaus	5	Totaal aantal ruiten	4
Dubbele ventilator	1	Soft Close systeem	Ja
Aantal lampen	2	Soft open & close scharnieren	Ja
Soort verlichting	Halogeen	Inverter technologie	Ja
Lamp vervangbaar	Ja	Stirrer	Ja
Vermogen lamp	40 W	Chimney	Double
Automatische inschakeling verlichting bij openen deur	Ja	Koelsysteem	Centrifugal
Onderwarmte - vermogen	1200 W	Koelleiding	Dubbel
Grill - vermogen	1750 W	Reductie snelheid koelsysteem	Ja
Circulatie - vermogen	2000 W	Afmetingen bruikbare interne ovenruimte (hxbxd)	353x470x397 mm
Automatische uitschakeling verhittingselementen bij openen deur	Ja	Temperatuurregeling	Elektronisch
Deur openen	Standaard opening	Materiaal ovenruimte	Ever Clean emaille

Prestaties / energielabel



Netto inhoud	68 l	Effectief magnetronvermogen	900 W
Aantal ovens	1		

Meegeleverde accessoires



Luxury rack	1	Glazen ovenplaat	1
Geëmailleerde diepe bakplaat (50mm)	1	Telescopische geleiders, geheel uitschuifbaar	1
Inzetrooster	1	Kerntemperatuurmeter	Ja, multipoint

Elektrische aansluiting

Spanning	220-240 V	Frequentie	50/60 Hz
Stroom	13 A	Lengte voedingskabel	150 cm
Nominale aansluitwaarde	3000 W		

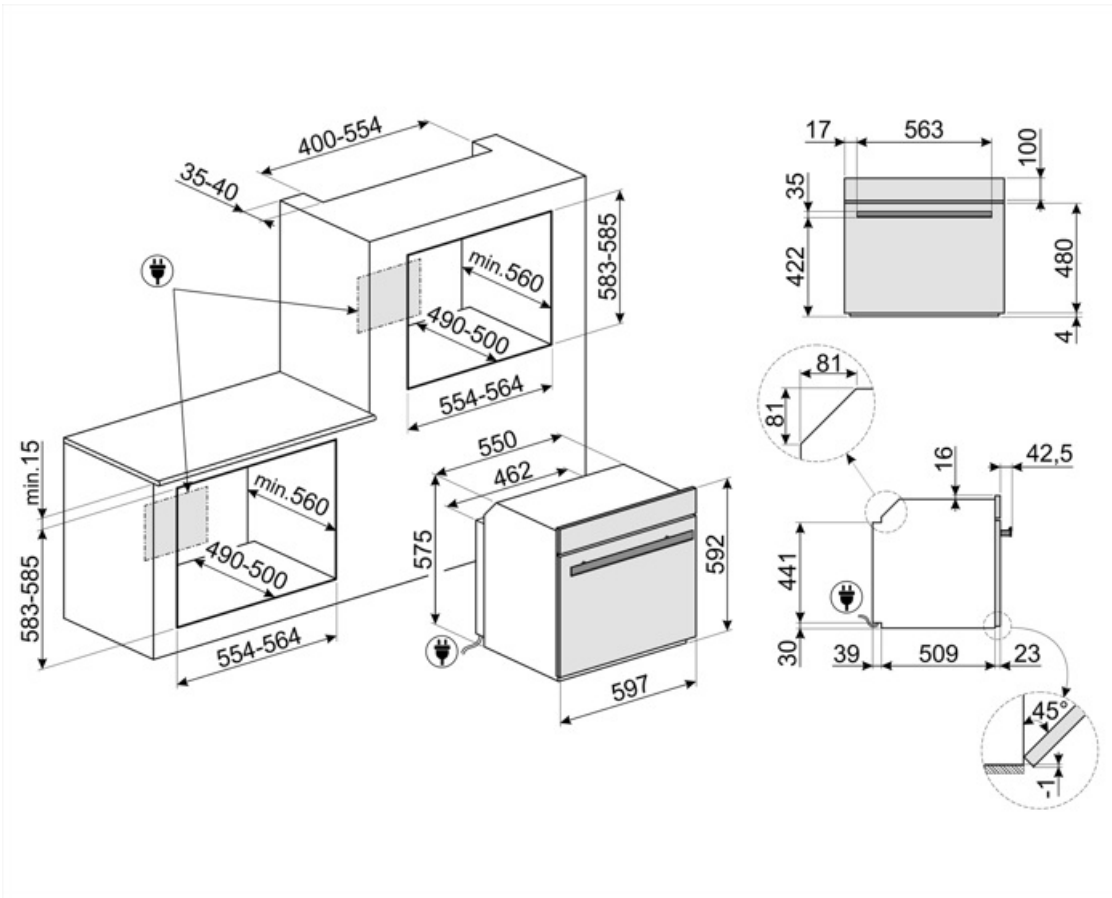

Accessoires niet inbegrepen

AIRFRY

Airfryerrek AIRFRY . Ideaal voor traditioneel frituren in de oven, maar met minder calorieën en minder vet. Hiermee creëer je snel en eenvoudig gerechten zoals frites, gebakken groenten en vis, waardoor ze perfect bruin en krokant worden.



ET20

Geëmailleerde bakplaat, 20 mm diep



GTP2

Gedeeltelijk uittrekbare telescopische geleiders (1 niveau), geschikt voor traditionele ovens. Ze zijn gemaakt van roestvrij staal en garanderen stabiliteit en vergemakkelijken het uitnemen van de trays.



PALPZ

Pizzaschep met inklapbare handgreep
breedte: 315 mm lengte: 325 mm



SFLK1

Kinderslot



BBQ

Dubbelzijdig



ET50

Geëmailleerde bakplaat, 50 mm diep



GTT2

Totally extractable telescopic guides (1 level), suitable for traditional ovens. Made in stainless steel, they guarantee stability and facilitate the smooth extraction of the trays.



PR3845X

Antifingerprint roestvrij staal.
Afdekstrip voor meubels in kolominstallatie van meer ovens



































STONE



















Rectangular refractory stone Ideal for cooking pizzas with the same results as a typical wood-fired oven. Can also be used for baking bread, focaccias and other recipes such as pies, flans or biscuits Dimensions:L42 x H1,8 x P37,5 cm.











Symbols glossary

	Kinderslot: sommige modellen zijn voorzien van een apparaat om het programma / de cyclus te vergrendelen zodat het niet kan per ongeluk veranderd		Combination microwave: This oven allows to combine two different ways of cooking (Traditional with microwaves). Combined ovens increase cooking opportunities, while providing maximum flexibility of household appliances.
	Ontdooien op tijd: met deze functie wordt automatisch het tijdstip van ontdooien van voedsel bepaald		Ontdooien op gewicht: Met deze functie wordt de ontdooitijd bepaald
	Viervoudige beglazing: aantal glazen deuren.		Automatische verlichting gaat uit: voor meer energiebesparing schakelt de verlichting automatisch uit na één minuut na het begin van de bereiding.
	ECO-logic: optie stelt u in staat om de vermogenslimiet van de werkelijke energiebesparing van het apparaat te beperken		Electric
	Geëmailleerde binnenkant: De geëmailleerde binnenkant van alle Smeg-ovens heeft een speciale antacidumvoering die helpt om de binnenkant schoon te houden door de hoeveelheid kookvet te verminderen.		Fresh Touch: Most of Smeg ovens have a "cool door." Thanks to the combination of tangential cooling and internal heat-reflecting glasses, the temperature on the outer surface of the door is maintained below 50° C. In addition to providing safety, this system protects the sides of the furniture from overheating by the oven.
	Ventilator met bovenste en onderste elementen: de elementen in combinatie met de ventilator zijn bedoeld om een meer gelijkmatige warmte te bieden, een methode die vergelijkbaar is met conventioneel koken, dus voorverwarmen is vereist. Het meest geschikt voor items die langzaam koken vereisen.		De ovenruimte wordt tegelijk door het onder- en bovenelement verwarmt. De hitteverdeling over het gerecht is afhankelijk van het niveau waarop men dit plaatst. Geschikt voor bakken op 1 niveau. Gerechten: alle ovenschotels, vlees, gevogelte, brood, (gevulde) taarten. Speciaal: gans en eend (bevatten veel vet).
	De ovenruimte wordt uitsluitend verhit door het onderelement. Voor gerechten die een hoge basistemperatuur behoeven, heeft deze bakstand weinig tot geen invloed op de korst aan de bovenzijde. Geschikt voor bakken op 1 niveau, ideaal voor deeggerechten die moeten rijzen (bijv. pizza). Bij gevulde taarten zal de deegbodem beter droog blijven.		Circulaire with lower element: The addition of the lower element adds extra heat at the base for food which requires extra cooking.
	Circulaire: it is the perfect function for cooking all types of dishes in a more delicate way. The heat comes from the back of the oven and is distributed quickly and evenly The fan is active. It is also ideal for cooking on multiple levels without mixing smells and flavors.		ECO: low energy consumption cooking: this function is particularly suitable for cooking on a single shelf with low energy consumption. It is recommended for all types of food except those that can generate a lot of moisture (for example vegetables). To achieve maximum energy savings and reduce time, it is recommended to put the food in the oven without preheating the cooking compartment

-  De warmte wordt geproduceerd door het grill- en bovenelement. Verhitting over het volledige oppervlak. De thermostaat wordt, afhankelijk van het gerecht, in de regel op de maximale stand gezet. Bij een korte baktijd kan de ovendeur gesloten blijven; bij langere baktijd blijft deze gedeeltelijk geopend. Voor vleesgerechten (klein- en middelgroot), vleespennen, vis, groenten, gratineren etc.
-  Microwave: Penetrating straight into the food, microwaves cook very quickly and with considerable energy savings. Suitable for cooking without fat, they are also able to thaw and heat food without altering its original appearance and aroma. The microwave function can also be combined with conventional functions with all the resulting advantages. Ideal for all types of food.
-  Microwave + grill element: The use of the grill results in a perfect browning of the surface of the food. The action of microwaves allows instead of cooking in a short time the internal part of the food.
-  This function can reheat precooked dishes, without becoming dry or hard.
-  Turbo: the heat comes from 3 directions: above, below and from the back of the oven The fan is active. It allows quick cooking, even on several shelves without mixing the aromas. Ideal for large volumes or foods that require intense cooking.
-  KEEP_WARM_72dpi
-  Plate rack warming: function for heating or keeping dishes warm. Place the baking tray on the lowest shelf and stack the dishes to be heated.
-  Air at 40°C provides the perfect environment for proving yeast type dough mixes. Simply select the function and place dough in the cavity for allotted
-  Ventilator met grillelement: De ventilator vermindert de felle hitte van de grill en biedt een uitstekende methode om verschillende soorten voedsel, karbonades, steaks, worstjes enz. Te grillen, waardoor het gelijkmatig bruin wordt en de warmte wordt verdeeld, zonder het voedsel uit te drogen. De bovenste twee niveaus die voor gebruik worden aanbevolen, en het onderste deel van de oven kunnen worden gebruikt om gerechten tegelijkertijd warm te houden, een uitstekende mogelijkheid bij het bereiden van een gegrild ontbijt. Halve grill (alleen middengedeelte) is ideaal voor kleine hoeveelheden voedsel.
-  Cooking with the simultaneous use of the heating element in combination with fan and microwave supply.
-  Fan combined with traditional cooking, where heat is generated from above and below, provides uniform heat. Adding the microwave function allows the same cooking results in less time.
-  Pizza function: Specific function for cooking pizza in a pan. It allows to obtain a pizza that is soft inside and crispy outside with the topping perfectly cooked, not dry and not burnt.
-  All glass inner door: All glass inner door, a single flat surface which is simple to keep clean.
-  verlichting
-  Temperature probe: with the temperature probe it is possible to perfectly cooking roasts, loins, meat of various cuts and sizes. In fact, the probe improve food cooking, thanks to the precise control of the temperature at the heart of the dish. The core temperature of the food is measured by a special sensor located inside the tip. When the instant temperature reaches the target temperature set by the user, cooking is finished
-  Rapid preheating: cooking is preceded by the preheating phase which allows the cooking compartment to reach the set temperature. This option reduces the time by up to 50%.

- | | |
|---|--|
|  <p>SABBATH: function that allows to cook food respecting Judaism's day of rest provisions.</p> |  <p>Option designed to solve any doubts More than 100 pop-ups, which can be triggered with a long touch on any icon, provide information on the use of the display and cooking.</p> |
|  <p>The oven cavity has 5 different cooking levels.</p> |  <p>Smart Cooking is the perfect recipe for every occasion. Meat, fish, pasta, desserts, etc . up to 150 automatic recipes that allow to make any preparation in a single click. Decide your menu and then the oven takes care of the rest.</p> |
|  <p>Soft close: all models are equipped with advanced function of smooth closing of the door, which allows the device to close smoothly and quietly.</p> |  <p>Telescopic rails: allow you to pull out the dish and check it without having to remove it from the oven entirely.</p> |
|  <p>Electronic control: Allows you to maintain temperature inside the oven with the precision 2-3 ° C. This enables to cook meals that are very sensitive to temperature changes, such as cakes, souffles, puddings.</p> |  <p>Touch control: dankzij de gebruiksvriendelijke Touch control kan het apparaat met één druk op de knop worden geprogrammeerd.</p> |
|  <p>Vapor Clean: a simple cleaning function using steam to loosen deposits in the oven cavity.</p> |  <p>The capacity indicates the amount of usable space in the oven cavity in litres.</p> |
|  <p>The capacity indicates the amount of usable space in the oven cavity in litres.</p> |  <p>The 4.3" VIVOscreen display offers an advanced colour touch interface, for automatic management of firing programmes such as Delta T, Multi-step and SameTime firing.</p> |
|  <p>Keep warm: the function allows to keep cooked food warm.</p> |  <p>INSTANT GO: activating this option allow to start cooking immediately. Preheating is included in the cooking time and the oven will gradually reach the desired temperature Particularly suitable for frozen foods.</p> |
|  <p>Active and controlled microwave distribution The Microwave Stirrer fan distributes the waves evenly within the oven, reducing the need for a turntable.</p> |  <p>The multi-point temperature probe has three detection points. This means that not only the core temperature is detected, but also the temperature in other areas. The oven will process all these data to avoid cooking unevenness. In this way each product can be cooked in a professional, restaurant style.</p> |
|  <p>The perfect way to have a complete menu in a few simple steps with a considerable saving of time. The large cavity can accommodate multiple types of food at the same time, which can be cooked without any exchange of odors. The carefully studied thermodynamic flows ensure uniform cooking at every level. The SameTime algorithm calculates the times, the cooking functions and all the parameters so that 3 foods can be ready at the same time</p> |  <p>The inverter technology allows to generate microwaves continuously and at the desired power The constant flow, without on and off cycles, allows you to precisely control the temperature, reduce times, avoids wasting energy and allows you to obtain excellent cooking, defrosting and re-heating results, thanks to the smaller difference between core and surface temperature in food</p> |

-
- | | |
|---|--|
|  <p>Dedicated cooking function for the double sided plate BBQ. Suitable for recreating succulent and crispy dishes in the oven with the typical taste of grilled cooking. The ribbed side is particularly suitable for meats and cheeses; the smooth side for fish, seafood and vegetables.</p> |  <p>Speciale kookfunctie voor het Airfryerrek AIRFRY. Ideaal voor het nabootsen van traditioneel frituren in de oven, maar met minder calorieën en minder vet. Hiermee kook je snel en eenvoudig gerechten zoals frites, gebakken groenten en vis, waardoor ze perfect bruin en krokant worden.</p> |
|  <p>Dedicated cooking function for the rectangular refractory stone PPR2 Dimensions Ideal for cooking pizzas with the same results as a typical wood-fired oven. Can also be used for baking bread, focaccias and other recipes such as pies, flans or biscuits</p> |  <p>The double chimney technology create a special airflow inside the cavity that reduce the condensation inside the cavity during microwave cooking, where the cavity is cold and the food is warm</p> |
|  <p>DeltaT cooking The oven automatically sets the cavity temperature to a predefined temperature (named deltaT) higher than the core temperature detected by the probe. When the probe detects an extra degree at the core, the oven automatically increases also its internal temperature by one degree. The oven offers the possibility to choose between three different deltaT cooking modes (slow, medium and fast) and to set any desired core temperature. A concentration of technology that makes it possible to obtain tender, juicy, healthy products of the highest quality.</p> |  <p>Function to melt butter and chocolate without using the bain-marie</p> |
|  <p>Function to soften butter and cheese It is useful for quickly bringing frozen desserts to serving temperature The function can also be used to soften ice cream</p> |  <p>Function for the preparation of popcorn packaged in bags</p> |