

# SOP6606WS2PNR



Category	60cm
Product Family	Oven
Power supply	Electric
Heat source	Electric
Cooking method	Combi Steam
Galileo cavity	SteamOne
Cleaning system	Pyrolytic
EAN code	8017709310066



## Aesthetics

Aesthetics	Dolce Stil Novo	Glass Type	Eclipse
Colour	Black	Door	Full glass
Finishing	Gloss	Handle	Dolce Stil Novo
Design	Flat	Handle Colour	Black
Component finish	Copper	Logo	Applied
Material	Glass		

## Controls

			
Display name	VivoScreen max	No. of display languages	20
Display technology	TFT	Display languages	Italiano, English (UK), Français (FR), Français (CA), Nederlands, Español (ES), Español (MX), Português (PT), Svenska, Русский, Deutsch (DE), Dansk, Norsk, Polski, English (AU), Suomi, Ukrainian, Kazakh, Afrikaans (ZA), Zulu (ZA)
Control setting	Advanced full touch		

## Programs / Functions

No. of cooking functions	19
Automatic programmes	150
Steam assisted levels	3

## Customisable recipes

10

### Traditional cooking functions



Static



Fan assisted



Circulaire



Turbo (circulaire + bottom + upper + fan)



ECO



Large grill



Fan grill (large)



Base



Circulaire + bottom



Pizza

### Cooking functions with pulsed steam



Fan assisted



Circulaire



Circulaire + Bottom + Fan



Turbo (circulaire + bottom + upper + fan)



Fan Grill

### Cooking functions with steam



Steam + bottom + upper + fan



Steam + circulaire + fan

Turbo

Grill + fan

### Other Steam functions



Tank cleaning



Water outlet



Water input



Descaling

### Other functions



Defrost by time



Defrost by weight



Proving



Stone cooking



BBQ



Air-Fry



Keep warm



Plate rack/warmer



Sabbath

### Cleaning functions



Pyrolytic

## Options



<b>Time-setting options</b>	Delay start and automatic end cooking	<b>SameTime</b>	Yes
<b>Minute minder</b>	Yes	<b>DeltaT cooking</b>	Yes
<b>Timer</b>	3	<b>Showroom demo option</b>	Yes
<b>Controls Lock / Child Safety</b>	Yes	<b>Demo-tutorial mode</b>	Yes
<b>Other options</b>	Keep warm, Eco light, Language setting, Digital clock display, Brightness, Tones, Tones volume	<b>Touch guide</b>	Yes
<b>Cooking with probe thermometer</b>	Yes	<b>History</b>	Yes, the last 10 functions utilised
<b>Multi-step cooking</b>	Yes, up to 3 steps	<b>Rapid pre-heating</b>	Yes
<b>Smart cooking</b>	Yes	<b>Instant GO</b>	Yes

## Technical Features



<b>Minimum Temperature</b>	30 °C	<b>Full glass inner door</b>	Yes
<b>Maximum temperature</b>	280 °C	<b>Removable inner door</b>	Yes
<b>Shelf positions</b>	5	<b>Total no. of door glasses</b>	4
<b>No. of lights</b>	2	<b>Soft Close hinges</b>	Yes
<b>Light type</b>	Halogen	<b>Soft Open</b>	Yes
<b>User-replaceable light</b>	Yes	<b>Chimney</b>	Fixed
<b>Light power</b>	40 W	<b>Cooling system</b>	Tangential
<b>Light when door is opened</b>	Yes	<b>Cooling duct</b>	Double
<b>Lower heating element power</b>	1200 W	<b>Speed Reduction Cooling System</b>	Yes
<b>Upper heating element - Power</b>	1000 W	<b>Door Lock During Pyrolysis</b>	Yes
<b>Grill element - power</b>	1700 W	<b>Steam range</b>	20 - 40%
<b>Large grill - Power</b>	2700 W	<b>Usable cavity space dimensions (HxWxD)</b>	353x470x401 mm
<b>Circular heating element - Power</b>	2000 W	<b>Temperature control</b>	Electronic
<b>Heating suspended when door is opened</b>	Yes	<b>Cavity material</b>	Easy clean enamel
<b>Door opening type</b>	Standard opening	<b>Water loading</b>	Drawer, manual
<b>Door</b>	Cool	<b>Tank capacity</b>	0,8 l
<b>Removable door</b>	Yes		

## Performance / Energy Label



<b>Energy efficiency class</b>	A+	<b>Energy consumption in forced air convection</b>	2.45 MJ
<b>Net volume of the cavity</b>	68 litres		

Energy consumption per cycle in conventional mode 1.09 KWh

Energy consumption in conventional mode 3.92 MJ

Energy consumption per cycle in fan-forced convection 0.68 KWh

Number of cavities 1  
Energy efficiency index 81 %

## Accessories Included



Premium rack 1  
Enamelled tray (20mm) 1  
Enamelled deep tray (50mm) 1  
Grill mesh 1

Telescopic Guide rails, total Extraction 1  
Temperature probe Yes, multipoint  
Other water loading kit

## Electrical Connection

Voltage 220-240 V  
Current 13 A  
Nominal power (W) 3000 W

Frequency (Hz) 50/60 Hz  
Power supply cable length 150 cm

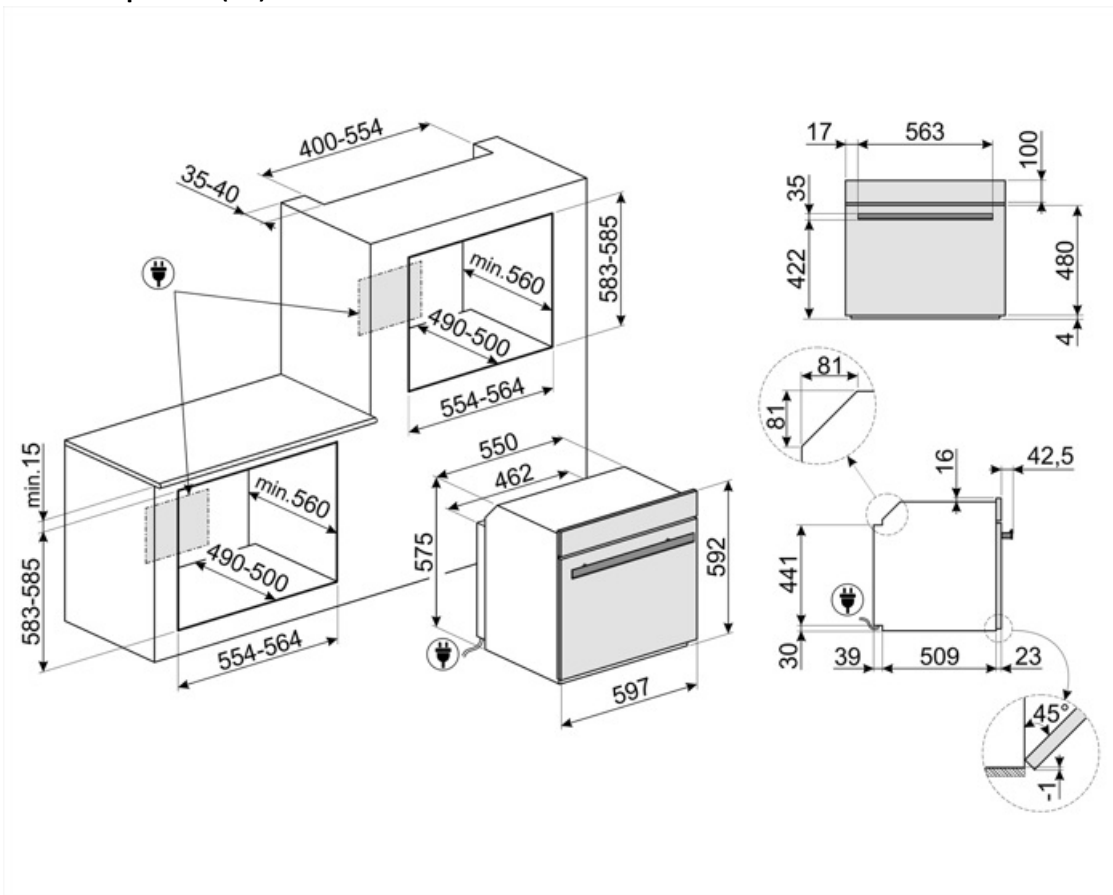

## Not included accessories

### AIRFRY

Air fryer rack AIRFRY . Ideal for recreating traditional frying in the oven, but with fewer calories and less fat. It allows you to cook quickly and simply dishes such as French fries, fried vegetables and fish, ensuring perfect browning and crispiness.



### BN620-1

Enamelled tray, 20mm deep



### ET20

Enamelled tray, 20mm deep



### GTP2

Partially extractable telescopic guides (1 level), suitable for traditional ovens. Made in stainless steel, they guarantee stability and facilitate the smooth extraction of the trays.



### PALPZ

Pizza shovel with fold away handle  
width: 315mm length : 325mm



### STONE

Rectangular refractory stone. Ideal for cooking pizzas with the same results as a typical wood-fired oven. Can also be used for baking bread, focaccias and other recipes such as pies, flans or biscuits Dimensions:L42 x H1,8 x P37,5 cm.



### BBQ

Double sided plate BBQ. Suitable for recreating succulent and crispy dishes in the oven with the typical taste of grilled cooking. The ribbed side is particularly suitable for meats and cheeses. The smooth side for fish, seafood and vegetables.



### BN640

Enamelled tray, 40mm deep



### ET50

Enamelled tray, 50mm deep

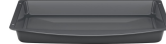

### GTT2

Totally extractable telescopic guides (1 level), suitable for traditional ovens. Made in stainless steel, they guarantee stability and facilitate the smooth extraction of the trays.







































### PR3845N

Black spacer cover for furniture when more ovens are installed in column. Suitable for 45cm Dolce Stil Novo compact ovens.



## Symbols glossary

 <p>A+: Energy efficiency class A+ helps to save up to 10% energy compared to class A. Maximum performance with minimum consumption is guaranteed.</p>	 <p>Child lock: some models are fitted with a device to lock the programme/cycle so it cannot be accidentally changed.</p>
 <p>Combination steam: ovens can be used either as a steam oven, or as a traditional oven, or alternatively the two methods can be combined.</p>	 <p>Air cooling system: to ensure a safe surface temperatures.</p>
 <p>Defrost by time: with this function the time of thawing of foods are determined automatically.</p>	 <p>Defrost by weight: With this function the defrosting time is determined</p>
 <p>Descaling function: Is essential to remove excess deposits of limestone in the tank and allow the proper operation of the product. The need to perform this operation is signaled by the product itself.</p>	 <p>Quadruple glazed: Number of glazed doors.</p>
 <p>Automatic lighting switches off: for greater energy savings, the lighting switches off automatically after one minute from the start of cooking.</p>	 <p>Electric</p>
 <p>Enamel interior: The enamel interior of all Smeg ovens have a special antacid lining which helps keep the interior clean by reducing the amount of cooking grease adhering to it.</p>	 <p>Fresh Touch: Most of Smeg ovens have a "cool door." Thanks to the combination of tangential cooling and internal heat-reflecting glasses, the temperature on the outer surface of the door is maintained below 50° C. In addition to providing safety, this system protects the sides of the furniture from overheating by the oven.</p>
 <p>Fan with upper and lower elements: The elements combined with the fan aim to provide more uniform heat, a similar method to conventional cooking, so pre-heat is required. Most suitable for items requiring slow cooking methods.</p>	 <p>Upper and lower element only: a traditional cooking method best suited for single items located in the centre of the oven. the top pf the oven will always be hottest. Ideal for roast, fruit cakes, bread etc.</p>
 <p>Lower heating element only: This function is ideal for foods that require extra base temperature without browning, e.g. pastry dishes, pizza. Also suitable for slow cooking of stews and casseroles.</p>	 <p>Circulaire with lower element: The addition of the lower element adds extra heat at the base for food which requires extra cooking.</p>
 <p>Circulaire: The combination of the fan and circular element around it gives a hot air cooking method. This provides many benefits including no preheat if cook time is more than 20 minutes, no flavour transfer when cooking different foods at the same time, less energy, and shorter cook times. Good for all types of food.</p>	 <p>ECO: The combination of the grill, fan and lower element is particularly suitable for cooking small quantities of food.</p>

- |   |  |
|---|--|
|  <p><b>Grill element:</b> Using of grill gives excellent results when cooking meat of medium and small portions, especially when combined with a rotisserie (where possible). Also ideal for cooking sausages and bacon.</p>  |  <p><b>Fan with grill element:</b> The fan reduces the fierce heat from the grill, providing an excellent method of grilling various foods, chops, steaks, sausages etc. giving even browning and heat distribution, without drying out the food. The top two levels recommended for use, and the lower part of the oven can be used to keep items warm at the same time, an excellent facility when cooking a grilled breakfast. Half grill (centre portion only) is ideal for small quantities of food.</p> |
|  <p><b>Pizza function:</b> The simultaneous operation of three elements ensures an optimum cooking facility when used with the Smeg pizza stone.</p>  |  <p><b>Fan combined with traditional cooking,</b> where heat is generated from above and below, provides uniform heat. Adding the steam function allows the same cooking results in less time.</p>  |
|  <p><b>Circulaire element with steam:</b> Cooking with the simultaneous use of the circular heating element in combination with fan and steam supply.</p>   |  <p><b>FUN_STEAM_OTHER_WATER_IN_OUT_72dpi</b></p>   |
|  <p><b>Circulaire with upper and lower elements:</b> The use of the fan with both elements allows food to be cooked quickly and effectively, ideal for large joints that require thorough cooking. It offers a similar result to rotisserie, moving the heat around the food, instead of moving the food itself, enabling any size or shape to be cooked.</p> |  <p><b>Fan with grill with steam assist:</b> For creating a perfectly roasted meat joint. The extra moisture keeps the meat juicy and tender, whilst the heat from the turbo function creates the caramelised flavours we know and love.</p>  |
|  <p><b>Circulaire with steam assist:</b> Provides extra moisture to food during cooking. Excellent for bread baking. The moisture allows the bread dough to stretch further at the beginning of cooking, creating an aerated and light textured dough. The remaining part of the cooking process allows for the signature crust to form.</p>                |  <p><b>Circulaire + lower element with steam assist:</b> Ideal for reheating flans and quiches. This function will re-crisp the base, whilst filling will not dry out due to the additional moisture in the cooking cavity.</p>   |
|  <p><b>Circulaire with steam assist:</b> Provides extra moisture to food during cooking. Excellent for bread baking. The moisture allows the bread dough to stretch further at the beginning of cooking, creating an aerated and light textured dough. The remaining part of the cooking process allows for the signature crust to form.</p>                |  <p><b>Turbo with steam assist:</b> For creating a perfectly roasted meat joint. The extra moisture keeps the meat juicy and tender, whilst the heat from the turbo function creates the caramelised flavours we know and love.</p>   |
|  <p><b>All glass inner door:</b> All glass inner door, a single flat surface which is simple to keep clean.</p>   |  <p><b>The inner door glass:</b> can be removed with a few quick movements for cleaning.</p>  |
|  <p><b>Keep warm:</b> This function allows you to keep precooked foods warm.</p>  |  <p><b>Side lights:</b> Two opposing side lights increase visibility inside the oven.</p>   |
|  <p><b>Pyrolytic:</b> Pyrolytic cleaning cycles can be selected as necessary to automatically clean the oven interior.</p>  |  <p><b>Warming up:</b> An option for dish warming and keeping the prepared meals hot.</p>   |

- 

**Cooking with temperature probe:** It is possible to display the temperature detected by the probe and set a target temperature that the dish must reach. When the core of the dish reaches the desired temperature, cooking stops



**Air at 40°C** provides the perfect environment for proving yeast type dough mixes. Simply select the function and place dough in the cavity for allotted
- 

**Rapid preheat:** The rapid preheat function can be used to reach the selected temperature in just a few minutes.



**Sabbath:** This function allows you to cook food whilst respecting the provisions of the Jewish day of rest.
- 

**Touch guide:** By holding down any symbol for 3 seconds you can get information on its function



The oven cavity has 5 different cooking levels.
- 

**Smart Cooking System:** for the perfect cooking it is simply necessary choosing the kind and the weight of food and the cooking temperature: any other setting will be established automatically.



**Appliances with Wi-Fi connectivity.** Via SmegConnect App is possible to monitor and remotely control appliances through smartphone and tablet (iOS and Android).
- 

**Soft close:** all models are equipped with advanced function of smooth closing of the door, which allows the device to close smoothly and quietly.



**Step cooking:** It is possible to set up to 3 cooking phases in the same recipe by varying function, time and / or temperature. At the end of a phase the next one will start automatically
- 

To guarantee the optimal functioning of the appliance, it is suggested to carry out the tank cleaning roughly once every 2-3 months.



**Telescopic rails:** allow you to pull out the dish and check it without having to remove it from the oven entirely.
- 

**Electronic control:** Allows you to maintain temperature inside the oven with the precision 2-3 ° C. This enables to cook meals that are very sensitive to temperature changes, such as cakes, souffles, puddings.



The capacity indicates the amount of usable space in the oven cavity in litres.
- 

Wi-Fi connectivity



The 6.3" VIVOscreen Max display is the most complete and advanced colour touch interface available for the automatic management of programmes such as Delta T, Multi-step and SameTime.
- 

...



**Instant go:** activating this option allows cooking to start immediately. Preheating is included in the cooking time and the oven will gradually reach the desired temperature. Particularly suitable for frozen foods.
- 

...



**Manual water loading system:** It is possible to load the tank in less than 40 seconds. The loading is done manually thanks to a special funnel included.
- 

**Sametime:** The perfect way to have a complete menu in a few simple steps. The SameTime algorithm calculates the times, the cooking functions and all the parameters so that 3 foods can be ready at the same time.



The capacity indicates the amount of usable space in the oven cavity in litres.





Dedicated cooking function for the double sided plate BBQ. Suitable for recreating succulent and crispy dishes in the oven with the typical taste of g



Dedicated cooking function for the rectangular refractory stone PPR2 Dimensions Ideal for cooking pizzas with the same results as a typical wood-fire



Dedicated cooking function for the Air fryer rack AIRFRY . Ideal for recreating traditional frying in the oven, but with fewer calories and less fat.



DeltaT cooking: The oven automatically sets the cavity temperature to a predefined temperature (named deltaT) higher than the core temperature detected by the probe. When the probe detects an extra degree at the core, the oven automatically increases also its internal temperature by one degree.