

SOPA6102TB3



Category	60cm
Product Family	Oven
Power supply	Electric
Heat source	ELECTRICITY
Cooking method	Thermoseal
Galileo Technology	Traditional pyro
Cleaning system	Pyrolitic
EAN code	8017709327774



Aesthetics

Aesthetic	Linea	Serigraphy type	Symbols
Colour	Black	Door	Full glass
Finishing	Glossy	Handle	Linea minimal
Design	Flat	Handle Colour	Black
Material	Glass	Logo	Silk screen
Glass Type	Clear	Controls colour	Matt black
Serigraphy colour	Grey		

Controls



Display name	EvoScreen	Control setting	Full touch
Display technology	LCD		

Programs / Functions

No. of cooking functions	10
--------------------------	----

Traditional cooking functions

Static	Fan assisted	Circulaire
Turbo	Eco	Large grill
Fan grill (large)	Base	Circulaire + bottom
Pizza		

Other functions

Defrost by time	Proving	Stone cooking
BBQ	Air-Fry	Sabbath

Cleaning functions

Pirólisis

Options



Time-setting options	Delay start and automatic end cooking	Other options	Keep warm, Eco light, Brightness, Tones
Minute minder	Yes	Showroom demo option	Yes
Timer	1	Rapid pre-heating	Yes
Controls Lock / Child Safety	Yes		

Technical Features



Minimum Temperature	30 °C	Removable door	Yes
Maximum temperature	280 °C	Full glass inner door	Yes
No. of shelves	5	Removable inner door	Yes
N. of fans	1	Total no. of door glasses	4
No. of lights	2	Soft Close hinges	Yes
Light type	Halogen	Soft Open	Yes
User-replaceable light	Yes	Chimney	Fixed
Light Power	40 W	Cooling system	Tangential
Light when door is opened	Yes	Cooling duct	Double
Lower heating element power	1200 W	Speed Reduction Cooling System	Yes
Grill element - power	1750 W	Door Lock During Pyrolysis	Yes
Circular heating element - Power	2000 W	Usable cavity space dimensions (HxWxD)	353x470x401 mm

Heating suspended when door is opened	Yes	Temperature control	Electronic
Door opening type	Standard opening	Cavity material	Ever clean Enamel
Door	Cool		

Performance / Energy Label



Energy efficiency class	A+	Energy consumption in forced air convection	2.45 MJ
Net volume of the cavity	68 l	Energy consumption per cycle in fan-forced convection	0.68 kWh
Energy consumption per cycle in conventional mode	1.09 kWh	Number of cavities	1
Energy consumption in conventional mode	3.92 MJ	Energy efficiency index	81 %

Accessories Included



Rack with back stop	1	Insert gird	1
Enamelled tray (20mm)	1	Telescopic Guide rails, partial Extraction	1
Enamelled deep tray (50mm)	1		

Electrical Connection

Plug	(I) Australia	Nominal power	3000 W
Voltage	220-240 V	Frequency (Hz)	50/60 Hz
Current	13 A	Power supply cable length	150 cm

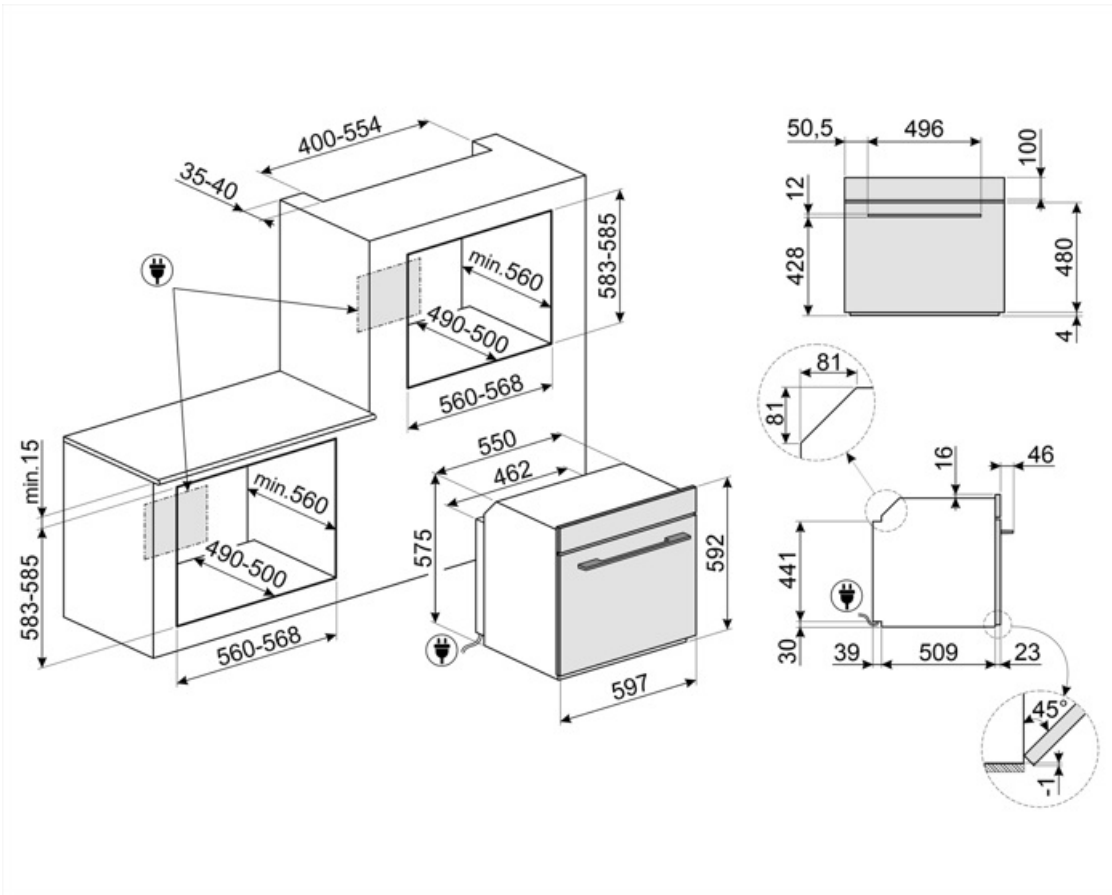

Not included accessories

AIRFRY

Air fryer rack AIRFRY . Ideal for recreating traditional frying in the oven, but with fewer calories and less fat. It allows you to cook quickly and simply dishes such as French fries, fried vegetables and fish, ensuring perfect browning and crispiness.



ET20

Enamelled tray, 20mm deep



GTP2

Partially extractable telescopic guides (1 level), suitable for traditional ovens. Made in stainless steel, they guarantee stability and facilitate the smooth extraction of the trays.



PALPZ

Pizza shovel with fold away handle width: 315mm length : 325mm



SFLK1

Child lock



BBQ

Double sided plate BBQ. Suitable for recreating succulent and crispy dishes in the oven with the typical taste of grilled cooking. The ribbed side is particularly suitable for meats and cheeses. The smooth side for fish, seafood and vegetables.



ET50

Enamelled tray, 50mm deep



GTT2

Totally extractable telescopic guides (1 level), suitable for traditional ovens. Made in stainless steel, they guarantee stability and facilitate the smooth extraction of the trays.



PR3845X

Antifingerprint stainless steel. Cover for furniture in column installation of more ovens









































STONE

Rectangular refractory stone PPR2. Ideal for cooking pizzas with the same results as a typical wood-fired oven. Can also be used for baking bread, focaccias and other recipes such as pies, flans or biscuits Dimensions:L42 x H1,8 x P37,5 cm.



Symbols glossary

 <p>A+: Energy efficiency class A+ helps to save up to 10% energy compared to class A. Maximum performance with minimum consumption is guaranteed.</p>	 <p>Child lock: some models are fitted with a device to lock the programme/cycle so it cannot be accidentally changed.</p>
 <p>Air cooling system: to ensure a safe surface temperatures.</p>	 <p>Defrost by time: with this function the time of thawing of foods are determined automatically.</p>
 <p>Quadruple glazed: Number of glazed doors.</p>	 <p>Automatic lighting switches off: for greater energy savings, the lighting switches off automatically after one minute from the start of cooking.</p>
 <p>Electric</p>	 <p>Enamel interior: The enamel interior of all Smeg ovens have a special antacid lining which helps keep the interior clean by reducing the amount of cooking grease adhering to it.</p>
 <p>Fresh Touch: Most of Smeg ovens have a "cool door." Thanks to the combination of tangential cooling and internal heat-reflecting glasses, the temperature on the outer surface of the door is maintained below 50° C. In addition to providing safety, this system protects the sides of the furniture from overheating by the oven.</p>	 <p>Fan with upper and lower elements: The elements combined with the fan aim to provide more uniform heat, a similar method to conventional cooking, so pre-heat is required. Most suitable for items requiring slow cooking methods.</p>
 <p>Upper and lower element only: a traditional cooking method best suited for single items located in the centre of the oven. the top pf the oven will always be hottest. Ideal for roast, fruit cakes, bread etc.</p>	 <p>Lower heating element only: This function is ideal for foods that require extra base temperature without browning, e.g. pastry dishes, pizza. Also suitable for slow cooking of stews and casseroles.</p>
 <p>Circulaire with lower element: The addition of the lower element adds extra heat at the base for food which requires extra cooking.</p>	 <p>Circulaire: The combination of the fan and circular element around it gives a hot air cooking method. This provides many benefits including no preheat if cook time is more than 20 minutes, no flavour transfer when cooking different foods at the same time, less energy, and shorter cook times. Good for all types of food.</p>
 <p>ECO: The combination of the grill, fan and lower element is particularly suitable for cooking small quantities of food.</p>	 <p>Grill element: Using of grill gives excellent results when cooking meat of medium and small portions, especially when combined with a rotisserie (where possible). Also ideal for cooking sausages and bacon.</p>
 <p>Fan with grill element: The fan reduces the fierce heat from the grill, providing an excellent method of grilling various foods, chops, steaks, sausages etc. giving even browning and heat distribution, without drying out the food. The top two levels recommended for use, and the lower part of the oven can be used to keep items warm at the same time, an excellent facility when cooking a grilled breakfast. Half grill (centre portion only) is ideal for small quantities of food.</p>	 <p>Pizza function: The simultaneous operation of three elements ensures an optimum cooking facility when used with the Smeg pizza stone.</p>

- | | |
|--|---|
|  <p>Circulaire with upper and lower elements: The use of the fan with both elements allows food to be cooked quickly and effectively, ideal for large joints that require thorough cooking. It offers a similar result to rotisserie, moving the heat around the food, instead of moving the food itself, enabling any size or shape to be cooked.</p> |  <p>All glass inner door: All glass inner door, a single flat surface which is simple to keep clean.</p> |
|  <p>The inner door glass: can be removed with a few quick movements for cleaning.</p> |  <p>KEEP_WARM_72dpi</p> |
|  <p>Side lights: Two opposing side lights increase visibility inside the oven.</p> |  <p>Pyrolytic: Pyrolytic cleaning cycles can be selected as necessary to automatically clean the oven interior.</p> |
|  <p>Air at 40°C provides the perfect environment for proving yeast type dough mixes. Simply select the function and place dough in the cavity for allotted</p> |  <p>Rapid preheat: The rapid preheat function can be used to reach the selected temperature in just a few minutes.</p> |
|  <p>Sabbath: This function allows you to cook food during the Sabbath, the Holiday of rest in the Jewish religion, respecting the precepts. The oven works</p> |  <p>The oven cavity has 5 different cooking levels.</p> |
|  <p>Soft close: all models are equipped with advanced function of smooth closing of the door, which allows the device to close smoothly and quietly.</p> |  <p>Telescopic rails: allow you to pull out the dish and check it without having to remove it from the oven entirely.</p> |
|  <p>Electronic control: Allows you to maintain temperature inside the oven with the precision 2-3 ° C. This enables to cook meals that are very sensitive to temperature changes, such as cakes, souffles, puddings.</p> |  <p>Touch controls: Easy to use touch controls allow the appliance to be programmed at the touch of a button.</p> |
|  <p>The capacity indicates the amount of usable space in the oven cavity in litres.</p> |  <p>...</p> |
|  <p>The capacity indicates the amount of usable space in the oven cavity in litres.</p> |  <p>Dedicated cooking function for the double sided plate BBQ. Suitable for recreating succulent and crispy dishes in the oven with the typical taste of g</p> |
|  <p>Dedicated cooking function for the Air fryer rack AIRFRY . Ideal for recreating traditional frying in the oven, but with fewer calories and less fat.</p> |  <p>Dedicated cooking function for the rectangular refractory stone PPR2 Dimensions Ideal for cooking pizzas with the same results as a typical wood-fire</p> |