

SR364SA

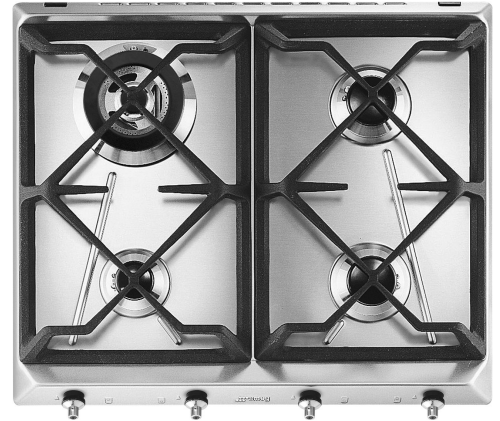

Product Family
Built-in type
Dimensions
Power supply
Type
EAN code

Hob
Traditional
60 cm
Gas
Gas
8017709294526



Aesthetics



Aesthetic
Colour
Finishing
Material
Type of steel
Pan stands
Type of control setting
Control knob position
No. of controls
Controls colour
Serigraphy colour

Classica
Stainless steel
Satin
Stainless Steel
Brushed
Cast iron
Control knobs
Front
4
Silver
Grey

Programs / Functions

No. of gas cook zones 4
Total no. of cook zones 4

Options



Worktop Cut-Out 478-482x555-560 mm

Technical Features

UR

Front-left - Gas - AUX - 1.10 kW

Rear-left - Gas - UR - 3.30 kW

Rear-right - Gas - Semi Rapid - 1.70 kW

Front-right - Gas - Semi Rapid - 1.70 kW

Gas safety valves Yes Automatic Ignition Yes

Accessories Included

Cast iron wok support 1

Electrical Connection



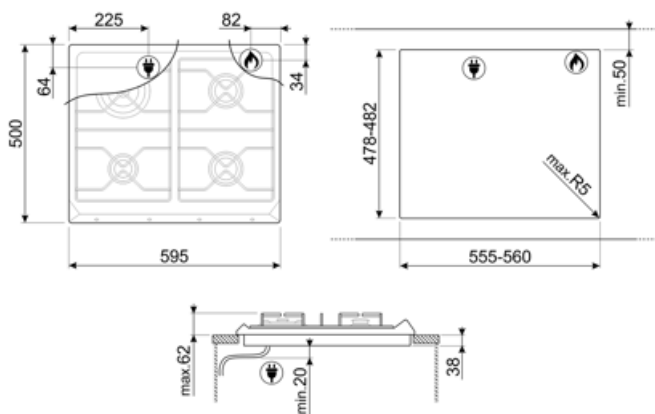

Plug	Not present	Type of electric cable installed	Yes, Single phase
Electrical connection rating (W)	1 W	Frequency (Hz)	50/60 Hz
Voltage (V)	220-240 V	Power supply cable length	120 cm

Gas Connection

Gas Type	G30 GPL Liquid gas	Other gas connections provided	Conical
Gas connection	Cilindrica	Gas connection rating (W)	7800 W
Other gas nozzles included	G110 City gas, G20 Natural gas		



Symbols glossary

- | | | | |
|--|--|---|--|
|  | Standard installation: Traditional installation in tabletop, suitable for any kitchen sets |  | Heavy duty cast iron pan stands: for maximum stability and strength. |
|  | Knobs control |  | CUT_OUT_STANDARD_72dpi |
|  | Ultra rapid burners: Powerful ultra rapid burners offer up to 5kw of power. | | |