

ST353BQL



Product Family	Dishwashers
Commercial width	60 cm
Commercial height	82 cm
Installation	Fully-integrated built-in
Kitchen panel	Not supplied
N° baskets	3, FlexiDuo
Motor	Inverter 2.0
EAN code	8017709306892



Programs



N. of programmes	10+1	Auto sensor 45-65	Yes
Washing temperatures	38, 45, 50, 55, 65, 70, 75 °C	Mix	Yes
Soak	Yes	Quiet (-2 dB)	Yes
Express 27'	Yes	Intense	Yes
Crystal	Yes	Self clean	Yes
Full express - 60 minutes	Yes	Hygiene 99,9%	Yes
ECO	Yes		

Options



Dry Assist+ option	Yes	1/2 load FlexiZone option	Yes
Delay timer option	Up to 24 hours	Special programs option	Yes

Baskets



Basket colour	Grey	Largest loadable dish in upper basket	19,0 cm
Basket components colour	Grey	Lower Basket	With 4 foldable racks
Handle	In plastic on upper and lower basket	Lower basket with anti-drip inserts	Yes

Upper Basket	With 1 foldable rack	Largest loadable dish in lower basket	30,0 cm
Glass holder	Yes	Colour Inner Components	Green
Height adjustment of the upper basket	On three levels (5 cm)		

Technical Features



Width (mm)	598 mm	Water supply	Single; cold/hot water max. 60°C - energysave with hot water up to 35%
Depth (mm)	545 mm	Max water hardness	100°FH;58°dH
Display type	LED display (3 digit)	Drying system	Natural condenser drying, with Dry Assist + automatic door opening system at the end of the cycle
Product Height (mm)	818 mm	Steam protection	In plastic
Controls	Electronic	Tube material	Stainless steel
Display	Delayed start, Programme time indicator	Filter	Stainless steel
Programme graphics	Symbols	Concealed heating element	Yes
On/off indicator	Yes	Hinges	Self balancing with fixed hinges
Salt light indicator	Light	Min. and max. frontal panel weight	2 - 9 kg
Rinse aid indicator	Light	Min. and max plinth height	100 - 228 mm
End of cycle indicator	ActiveLight	Adjustable feet	7cm, from 820 to 890 mm
Washing system	Planetarium	Back cover	Yes
Third spray arm	Single	Depth of dishwasher with open door (mm)	1146
Water softener	With electronic setting	Back feet adjustable from front	Yes
Turbidity sensor Aquatest	Yes	Top cover	In plastic
Flood protection system	Total Acquastop		

Performance / Energy Label - Reg. 2019



Energy Efficiency Class	B	Programme duration	4:25 h:min
Energy consumption [per 100 cycles, based on the eco programme]	64 kWh	Airborne acoustical noise emissions	45 dB(A) re 1 pW
Rated capacity (ps)	14	Airborne acoustical noise emission class	C
Water consumption [per cycle]	9,0 litres	Energy efficiency Index (EEI)	37,8

Electrical Connection

Plug	(F;E) Schuko	Frequency (Hz)	50 Hz
Connected power	1800 W	Type of connection	Single-phase

Current
Voltage

10 A
220-240 V

Power supply cable
length

140 cm

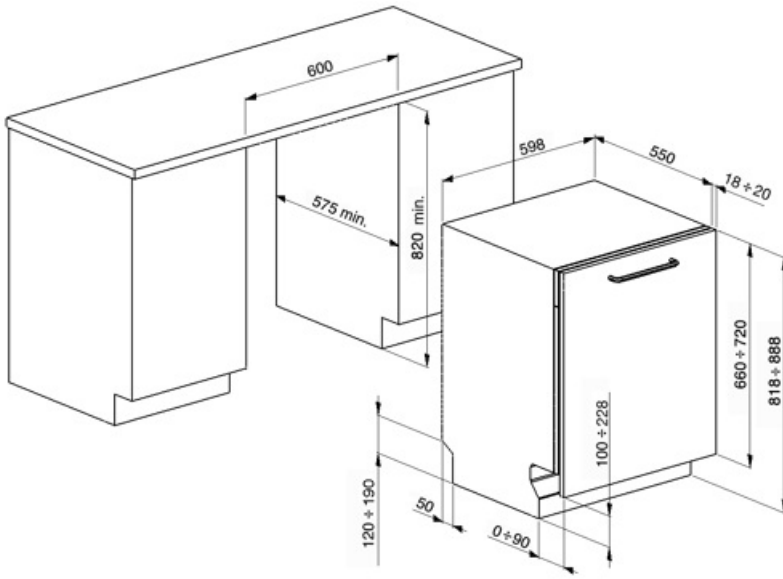

Not included accessories



KIT82CN



KIT82CX

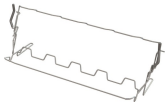

KITGH

Kit glass holder. It has to be fitted on the first basket but only if there are foldable racks



KITPL60FABB

Toekick Kit in White colour with adjustable height. Can be fitted over all the fully integrated and underbench models with Fixed Fulcrum. Can be installed also on the models with variable fulcrum or flexifit hinges.



KITPL60FABN

Toekick Kit in Black colour with adjustable height. Can be fitted over all the fully integrated and underbench models with Fixed Fulcrum. Can be installed also on the models with variable fulcrum or flexifit hinges.



KITPL60FABX



















Toekick Kit in Stainless Steel with adjustable height. Can be fitted over all the fully integrated and underbench models with Fixed Fulcrum. Can be installed also on the models with variable fulcrum or flexifit hinges.



KITPLV2

Kit extension for dishwasher and washing machine: lenght mt. 2

Symbols glossary

 <p>Activelight is an led light which projects a red spot onto the floor beneath the dishwasher when the appliance is in use.</p>	 <p>The Aquatest sensor is an electronic sensor that measures the degree of water transparency at the end of the initial soaking phase. Based on the values measured, the sensor sets the most suitable programme, thus obtaining the best washing results with the minimum amount of water.</p>
 <p>To improve the drying of dishes without leaving stains.</p>	 <p>Energy efficiency class B</p>
 <p>82 cm high</p>	 <p>Delay Timer: Option to postpone the start of the desired programme by up to 24 hours in order to programme the dishwasher to run at the desired time.</p>
 <p>The Dry Assist + option, in addition to saving energy, ensures perfect drying of the dishes by opening the door automatically at the end of the washing cycle.</p>	 <p>FlexiDuo: The FlexiDuo 3rd cutlery basket allows you to arrange cutlery or small cups, ladles, or bulky utensils however you like: it consists of two separate and moveable modules.</p>
 <p>FlexiZone: The ½ load flexizone allows you to wash a reduced load saving energy, water and time and there are no restrictions on where the items are placed.</p>	 <p>Noise Level: Excellent insulation and special devices keep noise to a minimum.</p>
 <p>The Planetarium washing system, with high rotations per minute, guarantees complete coverage of the tank, thanks to the simultaneous rotation of base and sprayers, and excellent washing results.</p>	 <p>Auto 45°- 65°: The auto programme regulates the length of a cycle depending on the need for a pre-wash and the number of rinses required.</p>
 <p>Crystals: The Crystals programme is dedicated to delicate dishes such as glasses and china.</p>	 <p>Eco: Eco, this economic wash programme uses a low amount of water and energy in order to provide the most environmentally friendly cleaning option.</p>
 <p>Mix: The Mix programme is suitable for mixed crockery and everyday pots and pans, without any particular incrustation.</p>	 <p>Soak programme: The soak programme provides a rinse to prevent dirt from drying.</p>
 <p>Express 27': The Express 27' programme is a quick wash cycle, at low temperatures, for lightly soiled dishes.</p>	 <p>Ultraclean: The Ultraclean option performs a final rinse at a high temperature of 70°C eliminating virtually all bacteria.</p>
 <p>Quick wash cycle for normally soiled mixed loads such as dishes and pans, even with dried-on residues. Dishes are washed and dried in 60 minutes.</p>	 <p>14 place settings: Number of place settings.</p>



Total Acquastop: In addition to the partial Acquastop protection present in all Smeg dishwashers, some models have an electronic device fitted to the water intake hose, which monitors water levels in the machine, detects leaks in the hose and switches off the water supply immediately when necessary.



Dishwasher cleaning cycle. The cycle should be started with the machine empty, without dishes. It is recommended to run the program every 2-3 months, using special dishwasher detergents.



Allows you to enable additional programs when selected together with any wash cycle. After having selected the required wash cycle, press the button (



The work aimed at continuous improvement has allowed the creation of the second generation of the Inverter motor 2.0, characterised by greater efficiency and durability over time, which allows very high performance and a lower energy consumption and noise level.



System WaterSave ensures the best washing results with minimal water consumption depending on the model of dishwasher.



SILENT: Wash cycle suitable for normally soiled dishes, even with dried-on residues. Ensures maximum noise reduction and is therefore ideal if you wish to run it during the night.



HYGIENE 99.9% High-temperature washing programme. The 75° rinse guarantees the removal of 99.9% of germs and bacteria.

Benefit (TT)

Active Light

Maximum control thanks to the light projected on the floor that indicates when the dishwasher is running and when the cycle is complete

Smeg dishwashers equipped with ActiveLight signal the appliance's activity status by projecting a light on the floor while the cycle is running. The light goes out at the end of the cycle, signalling that the dishwasher can be unloaded.

FlexiDuo

The flexible third basket provides additional space, adapting to the load to accommodate various types of dishes, ensuring optimal organization and efficient use of interior capacity

The third FlexiDuo basket consists of two separate sections that can be handled independently of each other, stacked and/or removed, offering loading flexibility for every need. Depending on the arrangement, it allows cups, tall glasses, bulky utensils and pots and pans to be placed in the upper basket.

Planetarium Wash System

Full and deep wash coverage thanks to the advanced movement of the spray arm, an innovation patented by Smeg

Smeg's patented Planetarium Wash System guarantees impeccable cleaning. With a simultaneous double movement of the sprayer and 65 rotations per minute, it reaches every nook and cranny for extraordinary results. Dishes, glasses and utensils will be perfectly clean in no time. An intelligent system where efficiency and style meet, delivering brilliant results effortlessly.

DryAssist+

The Dry Assist+ system of automatic door opening at the end of the cycle ensures fast and energy-efficient drying