

STFABWH3



Product familie	Vaatwasser
Commerciële breedte	60 cm
Nishoogte	82 cm
Installatie	Under counter built-in
Deurpaneel	50's style door panel
Aantal manden	3 met FlexiDuo besteklade
Motor	Inverter 2.0
EAN-code	8017709305079



Programma's



Aantal programma's	10+1	Auto sensor 45-65	Ja
Wastemperatuur	38, 45, 50, 55, 65, 70, 75 °C	Mix	Ja
Weken	Ja	Stil (-2dB)	Ja
Snel 27'	Ja	Intensief	Ja
Glazen	Ja	Automatische reiniging	Ja
Snel - Volledig 60'	Ja	Hygiëne 99,9%	Ja
ECO	Ja		

Opties



Dry Assist+	Ja	FlexiZone ½ (halve beladingsmogelijkheid)	Ja
Start uitstel optie	Tot 24 uur, i.c.m. automatisch spoelen	Optie speciale programma's	Ja

Korven



Kleur korven	Grijs	Grootste bord in bovenste mand	19,0 cm
Kleur korfcomponenten	Grijs	Onderste mand	Met 4 neerklapbare rekken
Handgreep	In plastic with stainless steel insert on upper and lower basket	Onderste mand met anti-druppel systeem	Ja
Bovenste mand	Met 3 neerklapbare rekken		

Glass holder	Ja	Grootste bord in onderste mand	30,0 cm
Aanpasbare hoogte bij bovenste mand	3 niveaus	Kleur interne onderdelen	Grijs
Bovenste mand met EasyGlide systeem	Ja	Bestekmandje	No

Technische specificaties



Breedte product (mm)	598 mm	Water toevoer	Enkel; koud en warm water tot 60°C - energiebesparing tot 35%
Diepte product (mm)	584 mm	Maximale waterhardheid	100°FH;58°dH
Type display	1 cijfer	Droogstelsysteem	Natuurlijk condensatiedrogen, met DryAssist + automatische deuropening einde cyclus
Hoogte product (mm)	818 mm	Bescherming tegen stoom	Van plaatstaal
Bediening	Elektronisch	Materiaal kuip	Inox
Display	Instelling start uitstel	Filter	Inox
Grafische weergave programma's	Symbolen	Warmte element	Ja
Indicator aan/uit	Ja	Scharnieren	Zelfbalancerend met vast steunpunt
Indicator zout	Indicator (lampje)	Min. and max plinth height	98 - 168 mm
Indicator glansspoelmiddel	Indicator (lampje)	Aanpasbare voetjes	7 cm, van 820 tot 890 mm
Indicator einde cyclus	Geluidssignaal	Additional gaskets	Yes, with stainless steel plate
Wassysteem	Planetarium wassysteem	Bedekking achter	Ja
Derde sproeiarm	Enkel	Diepte vaatwasser met open deur (mm)	1146
Water verzachter	Elektronisch instelbaar	Achterste voetjes aanpasbaar vanaf voorkant	Ja
Aquatest	Ja	Bovenbedekking	Van kunststof
Aquastop	Total Aquastop		

Prestaties/Energie label - Reg. 2019

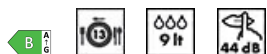

Energie-efficiëntieklasse	B	Duur langste programma	4:25 h:min
Energy consumption [per 100 cycles, based on the eco programme]	63 KWh	Geluidsniveau	44 dB(A) re 1 pW
Rated capacity (ps)	13	Emissieklasse voor akoestisch luchtgeluid	B
Water verbruik (per cyclus)	9,0 litres	Energy efficiency Index (EEI)	37,9

Elektrische aansluiting

Stekker	(F;E) Schuko	Frequentie	50 Hz
Aansluitwaarde	1800 W	Type of connection	Eenfasig
Stroom	10 A	Lengte voedingskabel	140 cm
Spanning	220-240 V		

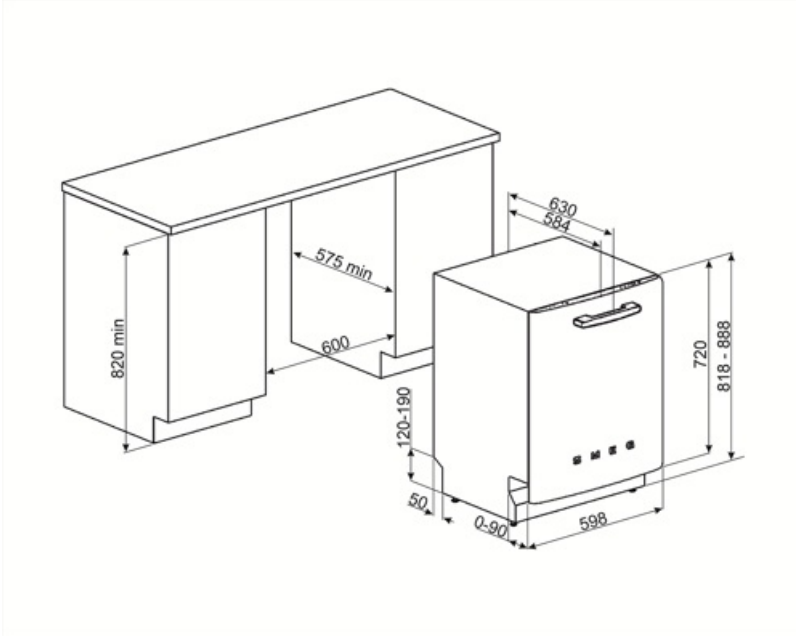

Not included accessories

KITGH

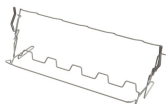

Kit glass holder. It has to be fitted on the first basket but only if there are foldable racks

KITPL60FABN



Toe kick Kit in Black colour with adjustable height. Can be fitted over all the fully integrated and underbench models with Fixed Fulcrum. Can be installed also on the models with variable fulcrum or flexifit hinges.

KITPLV2



Kit extension for dishwasher and washing machine: lenght mt. 2

KITPL60FABB























Toe kick Kit in White colour with adjustable height. Can be fitted over all the fully integrated and underbench models with Fixed Fulcrum. Can be installed also on the models with variable fulcrum or flexifit hinges.

KITPL60FABX



Toe kick Kit in Stainless Steel with adjustable height. Can be fitted over all the fully integrated and underbench models with Fixed Fulcrum. Can be installed also on the models with variable fulcrum or flexifit hinges.

Symbols glossary

	<p>The Aquatest sensor is an electronic sensor that measures the degree of water transparency at the end of the initial soaking phase. Based on the values measured, the sensor sets the most suitable programme, thus obtaining the best washing results with the minimum amount of water.</p>		<p>To improve the drying of dishes without leaving stains.</p>
	<p>82 cm high</p>		<p>Delay Timer: Option to postpone the start of the desired programme by up to 24 hours in order to programme the dishwasher to run at the desired time.</p>
	<p>EasyGlide: Convenient EasyGlide system for easy unloading of the appliance that allows reaching maximum flexibility of load of the machine.</p>		<p>FlexiDuo: The FlexiDuo 3rd cutlery basket allows you to arrange cutlery or small cups, ladles, or bulky utensils however you like: it consists of two separate and moveable modules.</p>
	<p>FlexiZone: The ½ load flexizone allows you to wash a reduced load saving energy, water and time and there are no restrictions on where the items are placed.</p>		<p>Noise Level: Excellent insulation and special devices keep noise to a minimum.</p>
	<p>The Planetarium washing system, with high rotations per minute, guarantees complete coverage of the tank, thanks to the simultaneous rotation of base and sprayers, and excellent washing results.</p>		<p>Het automatische programma regelt de lengte van een cyclus afhankelijk van de behoefte aan voorwas en het aantal benodigde spoelbeurten.</p>
	<p>Crystals: The Crystals programme is dedicated to delicate dishes such as glasses and china.</p>		<p>Het ECO programma is een economische wascyclus die een kleine hoeveelheid water en energie gebruikt voor de meest milieuvriendelijke reinigingsoptie.</p>
	<p>Het normaal programma is geschikt voor gemengde dagelijkse vaat en potten en pannen, zonder specifieke aangekoekte etensresten.</p>		<p>Het weekprogramma zorgt voor een spoeling om te voorkomen dat vuil opdroogt.</p>
	<p>Snel programma 27 minuten</p>		<p>De UltraClean optie voert een laatste spoeling uit op een hoge temperatuur van 70°C die 99,9% van alle bacteriën wegneemt.</p>
	<p>13 place settings: Number of place settings.</p>		<p>Total Acquastop: In addition to the partial Acquastop protection present in all Smeg dishwashers, some models have an electronic device fitted to the water intake hose, which monitors water levels in the machine, detects leaks in the hose and switches off the water supply immediately when necessary.</p>
	<p>System WaterSave ensures the best washing results with minimal water consumption depending on the model of dishwasher.</p>		<p>Voor normaal vervuilde gemengde ladingen zoals borden en pannen, zelfs met opgedroogde resten. De gerechten worden in 60 minuten gewassen en gedroogd.</p>



De vaatwasser voert een automatische zelfreinigingscyclus uit



Een wascyclus die gebruikt kan worden voor vervuilde vaat, zelf met opgedroogde resten. Deze cyclus heeft een minimaal geluidsniveau en is daarom ideaal om 's nachts te laten draaien.



Deze functie laat je toe de extra programma's te selecteren wanneer deze worden gecombineerd met eender welke wascyclus. Na de nodige wascyclus geselecteerd te hebben, duw op deze knop.



The Dry Assist + option, in addition to saving energy, ensures perfect drying of the dishes by opening the door automatically at the end of the washing cycle.



Energie-efficiëntieklasse



HYGINE 99,9% Wasprogramma op hoge temperatuur. De 75° spoeling garandeert de verwijdering van 99,9% van de ziektekiemen en bacteriën.



Het werk gericht op continue verbetering heeft de creatie mogelijk gemaakt van de tweede generatie van de Inverter-motor 2.0, die wordt gekenmerkt door een grotere efficiëntie en duurzaamheid in de loop van de tijd, wat zeer hoge prestaties en een lager energieverbruik en een lager geluidsniveau mogelijk maakt.



Benefit (TT)

FlexiDuo

The flexible third basket provides additional space, adapting to the load to accommodate various types of dishes, ensuring optimal organization and efficient use of interior capacity

The third FlexiDuo basket consists of two separate sections that can be handled independently of each other, stacked and/or removed, offering loading flexibility for every need. Depending on the arrangement, it allows cups, tall glasses, bulky utensils and pots and pans to be placed in the upper basket.

Planetarium Wash System

Full and deep wash coverage thanks to the advanced movement of the spray arm, an innovation patented by Smeg

Smeg's patented Planetarium Wash System guarantees impeccable cleaning. With a simultaneous double movement of the sprayer and 65 rotations per minute, it reaches every nook and cranny for extraordinary results. Dishes, glasses and utensils will be perfectly clean in no time. An intelligent system where efficiency and style meet, delivering brilliant results effortlessly.

DryAssist+

The Dry Assist+ system of automatic door opening at the end of the cycle ensures fast and energy-efficient drying