

STL324BQLH

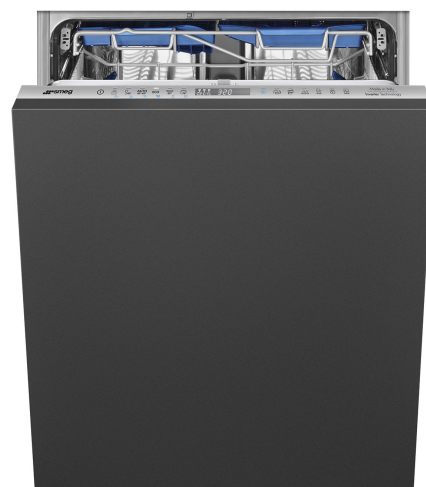

Familie	Vaatwasser
Commerciële breedte	60 cm
Nishoogte	Maxi, 86 cm
Installatie	Volledig geïntegreerd
Deur paneel	Niet meegeleverd
Aantal korven	3, FlexiDuo met Easy Glide
Motor	Inverter 2.0
EAN-code	8017709307462



Programs



Aantal programma's	12+2	Auto sensor 45-65	Ja
Wastemperatuur	38, 45, 50, 55, 65, 70, 75 °C	Mix	Ja
Weken	Ja	Stil (-2dB)	Ja
Snel 27'	Ja	Intensief	Ja
Krystal	Ja	Zelf reinigen	Ja
Snel - Volledig 60'	Ja	Hygiëne 99,9%	Ja
Eco	Ja	Delicate vaat	Ja
Groene expres	Ja	Trays	Ja

Opties

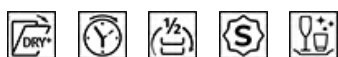

Dry Assist + opties	Ja	Optie speciale programma's	Ja
Delay timer optie	Tot 24 uur, i.c.m. automatisch spoelen	Clean&Shine option	Ja
FlexiZone ½ (halve beladingsmogelijkheid)	Ja		

Korven



Kleur korven	Grijs	Sliding Guides Extra Glide	Ja
Kleur korfcomponenten	Grijs		

Handgreep	Van kunststof met roestvrijstalen inzet op boven- en onderrek	Maximum afmetingen bord dat in bovenste korf kan worden geladen	19,0 cm
Bovenkorf	Met 3 opvouwbare rekken	Onderkorf	Met 4 opvouwbare rekken
Glazen houder	Ja	Onderkorf met anti-drup inserts	Ja
In hoogte verstelbare bovenkorf	3 niveaus	Maximum afmetingen bord dat in onderste korf kan worden geladen	35,0 cm
		Kleur binnenonderdelen	Blauw

Technische specificaties



Breedte product	598 mm	Maximale waterhardheid	100°fH;58°dH
Diepte product	550 mm	Droogstelsysteem	Natuurlijk condensor drogen met Dry Assist + automatische deuropeningssysteem aan het einde van de cyclus
Type display	LED display	Stoombeveiliging	Van kunststof
Hoogte product	858 mm	Materiaal kuip	Roestvrij staal
Bediening	Elektronisch Touch Control	Filter	Roestvrij staal
Display	Instelling Delay timer, Programma duur indicator, Consumptions	Verborgene verwarmingselement	Ja
Grafische weergave programma's	Symbolen	Scharnieren	Self balancing, Sliding, FLEXIFIT
Zout indicator	Indicator (lampje)	Min. en max. frontaal paneelgewicht	2,5 - 10 kg
Glansspoelmiddel indicator	Indicator (lampje)	Min. en max. plinthoogte	50 - 215 mm
Indicator einde cyclus	ActiveLight	Installeerbaar in kolom	Ja
Wassysteem	Planetarium	Verstelbare voetjes	7 cm, van 860 tot 930 mm
Derde sproeiarm	Enkel	Extra pakkingen	Ja, met roestvrijstalen plaat
Waterontkalker	Elektronisch instelbaar	Back cover	Ja
Aquatest sensor	Ja	Diepte vaatwasser met open deur (mm)	1168
Overstroombeveiliging	Total Acquastop	Voetjes achterzijde vanaf de voorkant regelbaar	Ja
Watertoevoer	Enkel; koud en warm water tot 60°C - energiebesparing tot 35%	Bovenbedekking	Van kunststof

Performance / Energy Label - Reg. 2019

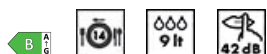

Energie-efficiëntieklasse B (wascyclus)	Programmaduur	4:25 h:min
	Geluidsniveau	42 dB(A) re 1 pW
	Akoestisch geluidsemissieklasse	B

Energy consumption 64 kWh
[per 100 cycles, based
on the eco programme]

Energy efficiency Index 37,8
(EEI)

Nominale capaciteit (ps) 14
Water verbruik (per
cyclus) 9,0 litres

Elektrische aansluiting

Stekker (F;E) Schuko
Aansluitwaarde 1800 W
Stroom 10 A
Spanning 220-240 V

Frequentie 50 Hz
Type aansluiting Single-phase
Lengte voedingskabel 140 cm

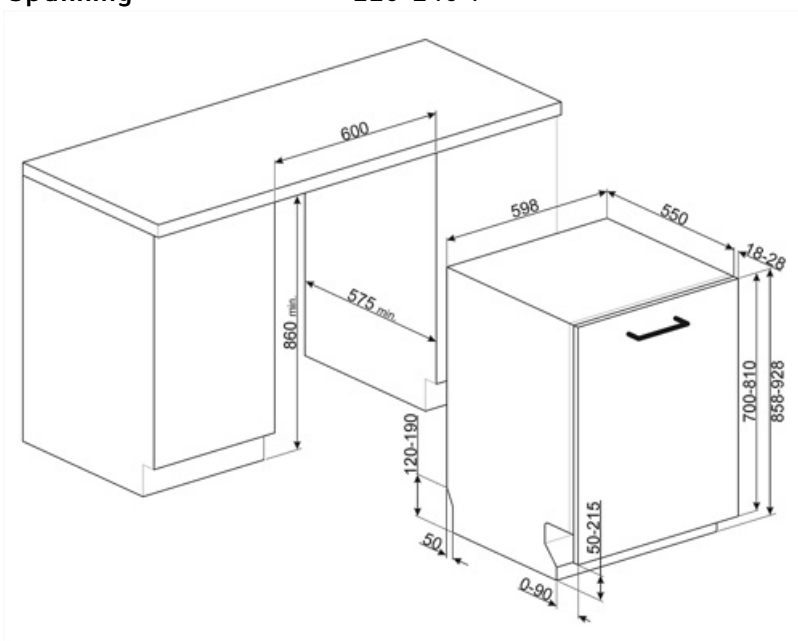

Accessoires niet inbegrepen



KIT86PORTAN-1



KIT86PORTX-1



KIT86PORTWH-1



KITFLEXI

Kit for 60cm dishwashers with FlexiFit hinges for door panel weight >11 kg (max 15 kg 82 cm and 13,5 kg 86 cm)

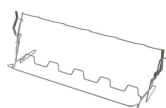

KITGH

Kit glazen houder. Deze moet op de eerste mand worden gemonteerd, maar alleen als er inklapbare rekken zijn



KITPL60B

Toekick Kit in witte kleur met verstelbare hoogte en diepte. Kan worden geïnstalleerd over alle volledig geïntegreerde modellen en modellen onderbouw met variabel draaipunt of flexifit-scharnieren.



KITPL60N

Toekick Kit in zwarte kleur met verstelbare hoogte en diepte. Kan worden geïnstalleerd over alle volledig geïntegreerde modellen en onderbouw modellen met variabel draaipunt of flexifit-scharnieren.



KITPL60X

























Toekick Kit in roestvrij staal met verstelbare hoogte en diepte. Kan worden gemonteerd over alle volledig geïntegreerde modellen en onderbouw modellen met variabel draaipunt of flexifit-scharnieren.













KITPLV2

Kit verlengstuk voor vaatwasser en wasmachine: lengte 2 mtr.

Symbols glossary

	<p>Activelight is een led die een rode stip projecteert op de vloer onder de vaatwasser als het apparaat in gebruik is</p>		<p>Aquatest meet de helderheid van het water tijdens een automatisch programma en zorgt automatisch voor een minimaal verbruik van water en energie</p>
	<p>To improve the drying of dishes without leaving stains.</p>		<p>Energy efficiency class B</p>
	<p>Clean&Shine option: For perfect cleaning results, this option adds an extra rinse to the wash cycle, which also gives the dishes a higher gloss.</p>		<p>Installation in column: Installation in column</p>
	<p>86 cm high</p>		<p>Vertragingstimer: De uitgestelde timer kan de start van het programma tot 24 uur uitstellen.</p>
	<p>FlexiDuo: The FlexiDuo 3rd cutlery basket allows you to arrange cutlery or small cups, ladles, or bulky utensils however you like: it consists of two separate and moveable modules.</p>		<p>The FlexiFit hinges allow the kitchen panel to slide over the dishwasher door, allowing a minimum kitchen plinth height of 5 cm.</p>
	<p>FlexiZone: The ½ load flexizone allows you to wash a reduced load saving energy, water and time and there are no restrictions on where the items are placed.</p>		<p>The ExtraGlide guides system makes the second basket run even smoother and softer. It facilitates movement even when fully loaded, and thanks to the increased excursion, facilitates the insertion of dishes into the basket.</p>
	<p>Noise Level: Excellent insulation and special devices keep noise to a minimum.</p>		<p>The Planetarium washing system, with high rotations per minute, guarantees complete coverage of the tank, thanks to the simultaneous rotation of base and sprayers, and excellent washing results.</p>
	<p>Auto 45°- 65°: The auto programme regulates the length of a cycle depending on the need for a pre-wash and the number of rinses required.</p>		<p>Crystals: The Crystals programme is dedicated to delicate dishes such as glasses and china.</p>
	<p>Delicate: Delicate washing program is designed for delicate dishes which are not heavily soiled.</p>		<p>Eco: Eco, this economic wash programme uses a low amount of water and energy in order to provide the most environmentally friendly cleaning option.</p>
	<p>Mix: The Mix programme is suitable for mixed crockery and everyday pots and pans, without any particular incrustation.</p>		<p>Soak programme: The soak programme provides a rinse to prevent dirt from drying.</p>
	<p>Express 27': The Express 27' programme is a quick wash cycle, at low temperatures, for lightly soiled dishes.</p>		<p>Ultraclean: The Ultraclean option performs a final rinse at a high temperature of 70°C eliminating virtually all bacteria.</p>
	<p>14 place settings: Number of place settings.</p>		<p>Total Acquastop: In addition to the partial Acquastop protection present in all Smeg dishwashers, some models have an electronic device fitted to the water intake hose, which monitors water levels in the machine, detects leaks in the hose and switches off the water supply immediately when necessary.</p>

-  Touch control: dankzij de gebruiksvriendelijke Touch control kan het apparaat met één druk op de knop worden geprogrammeerd.
-  GREEN EXPRESS Washing programme with low water and energy consumption.
-  Dishwasher cleaning cycle. The cycle should be started with the machine empty, without dishes. It is recommended to run the program every 2-3 months, using special dishwasher detergents.
-  Allows you to enable additional programs when selected together with any wash cycle. After having selected the required wash cycle, press the button (
-  Baking tray programme: for intensive cleaning of the oven trays. Place the trays in the lower basket of the dishwasher.
-  The work aimed at continuous improvement has allowed the creation of the second generation of the Inverter motor 2.0, characterised by greater efficiency and durability over time, which allows very high performance and a lower energy consumption and noise level.
-  System WaterSave ensures the best washing results with minimal water consumption depending on the model of dishwasher.
-  Quick wash cycle for normally soiled mixed loads such as dishes and pans, even with dried-on residues. Dishes are washed and dried in 60 minutes.
-  SILENT: Wash cycle suitable for normally soiled dishes, even with dried-on residues. Ensures maximum noise reduction and is therefore ideal if you wish to run it during the night.
-  The Dry Assist + option, in addition to saving energy, ensures perfect drying of the dishes by opening the door automatically at the end of the washing cycle.
-  HYGIENE 99.9% High-temperature washing programme. The 75° rinse guarantees the removal of 99.9% of germs and bacteria.

Benefit (TT)

Glassy Touch Display

The easy and intuitive lexan touch display guides the user towards conscious and sustainable choices, reducing waste

The display, featuring indicators for dirt level, water usage, and energy consumption, enables users to optimise efficiency, minimise waste, and address daily needs with an eco-conscious approach. With a range of available options, it allows for customised washing and consumption settings tailored to individual preferences, consistently delivering exceptional results with minimal environmental impact.

Active Light

Maximum control thanks to the light projected on the floor that indicates when the dishwasher is running and when the cycle is complete

Smeg dishwashers equipped with ActiveLight signal the appliance's activity status by projecting a light on the floor while the cycle is running. The light goes out at the end of the cycle, signalling that the dishwasher can be unloaded.

FlexiDuo

The flexible third basket provides additional space, adapting to the load to accommodate various types of dishes, ensuring optimal organization and efficient use of interior capacity

The third FlexiDuo basket consists of two separate sections that can be handled independently of each other, stacked and/or removed, offering loading flexibility for every need. Depending on the arrangement, it allows cups, tall glasses, bulky utensils and pots and pans to be placed in the upper basket.

Planetarium Wash System

Full and deep wash coverage thanks to the advanced movement of the spray arm, an innovation patented by Smeg

Smeg's patented Planetarium Wash System guarantees impeccable cleaning. With a simultaneous double movement of the sprayer and 65 rotations per minute, it reaches every nook and cranny for extraordinary results. Dishes, glasses and utensils will be perfectly clean in no time. An intelligent system where efficiency and style meet, delivering brilliant results effortlessly.

Flexifit hinge system

Smooth-running door for optimal integration into the kitchen design

The height of the plinth can vary from 5 cm to 21.5 cm, allowing it to fit perfectly into the cabinet. Thanks to this solution, the dishwasher blends harmoniously into its surroundings, with the door and plinth perfectly aligned with the other kitchen furniture.

Extra Glide Telescopic Guides

Smoother and more stable loading and unloading operations

Extra Glide telescopic guides ensure smooth and safe extraction of the upper basket, even with heavy loads. The telescopic design ensures smooth, stable and silent movement, improving ergonomics and convenience. Ideal for optimising space and ease of use, they combine durability and comfort in every washing operation.



Dry Assist+

The Dry Assist+ system of automatic door opening at the end of the cycle ensures fast and energy-efficient drying