

# SUK91MFX9

Cooker size	90x60 cm
N. of cavities with energy label	1
Cavity heat source	Electric
Hob type	Gas
Type of main oven	Thermo-ventilated
Cleaning system main oven	Vapor Clean
EAN code	8017709215040
Energy efficiency class	A



## Aesthetics



<b>Aesthetics</b>	Classic	<b>Control knobs</b>	Smeg Classic
<b>Series</b>	Concert	<b>Controls colour</b>	Stainless steel
<b>Design</b>	Standard	<b>No. of controls</b>	7
<b>Colour</b>	Stainless steel	<b>Serigraphy colour</b>	Black
<b>Finishing</b>	Brushed	<b>Display</b>	electronic 5 buttons
<b>Command panel finish</b>	Stainless steel	<b>Door</b>	With 2 horizontal strips
<b>Logo</b>	Embossed	<b>Glass type</b>	Stopsol
<b>Logo position</b>	Facia below the oven	<b>Handle</b>	Smeg Classic
<b>Upstand</b>	Yes	<b>Handle Colour</b>	Brushed stainless steel
<b>Hob colour</b>	Stainless steel	<b>Storage compartment</b>	Door
<b>Type of pan stands</b>	Cast Iron	<b>Plinth</b>	Black
<b>Type of control setting</b>	Control knobs		

## Programs / Functions

No. of cooking functions 8

Traditional cooking functions



Static



Fan assisted



Circulaire



ECO



Small grill



Large grill



Fan grill (large)



Fan assisted base

## Cleaning functions

 Vapor Clean

## Hob technical features

			
<b>Total no. of cook zones</b> 5			
Front left - Gas - Rapid - 2.90 kW			
Rear left - Gas - Semi Rapid - 1.80 kW			
Central - Gas - UR - 4.00 kW			
Rear right - Gas - Semi Rapid - 1.80 kW			
Front right - Gas - AUX - 1.00 kW			
<b>Type of gas burners</b>	Standard	<b>Gas safety valves</b>	Yes
<b>Automatic electronic ignition</b>	Yes	<b>Burner caps</b>	Matt black enamelled

## Main Oven Technical Features



<b>No. of lights</b>	2	<b>Removable inner door</b>	Yes
<b>Fan number</b>	2	<b>Total no. of door glasses</b>	3
<b>Net volume of the cavity</b>	115 litres	<b>No. of thermo-reflective door glasses</b>	2
<b>Gross volume, 1st cavity</b>	129 l	<b>Safety Thermostat</b>	Yes
<b>Cavity material</b>	Easy clean enamel	<b>Cooling system</b>	Tangential
<b>Shelf positions</b>	5	<b>Usable cavity space dimensions (HxWxD)</b>	371x724x418 mm
<b>Type of shelves</b>	Metal racks	<b>Temperature control</b>	Electro-mechanical
<b>Light type</b>	Halogen	<b>Lower heating element power</b>	1700 W
<b>Light power</b>	40 W	<b>Upper heating element - Power</b>	1200 W
<b>Cooking time setting</b>	Start and Stop	<b>Grill element</b>	1700 W
<b>Light when oven door is open</b>	Yes	<b>Large grill - Power</b>	2900 W
<b>Door opening</b>	Flap down	<b>Circular heating element - Power</b>	2 x 1550 W
<b>Removable door</b>	Yes	<b>Grill type</b>	Electric
<b>Full glass inner door</b>	Yes		

## Options Main Oven

<b>Timer</b>	Yes	<b>Minimum Temperature</b>	50 °C
<b>End of cooking acoustic alarm</b>	Yes	<b>Maximum temperature</b>	260 °C

## Accessories included for Main Oven & Hob

<b>Moka stand</b>	1	<b>40mm deep tray</b>	1
-------------------	---	-----------------------	---

Chrome shelf with back and side stop	1	Grill mesh	1
20mm deep tray	1		

## Electrical Connection

Max Power Draw	3200 W	Power supply cable length	120 cm
Current	14 A	Frequency	50/60 Hz
Voltage	220-240 V	Terminal block	3 poles
Type of electric cable	Yes, Single phase		

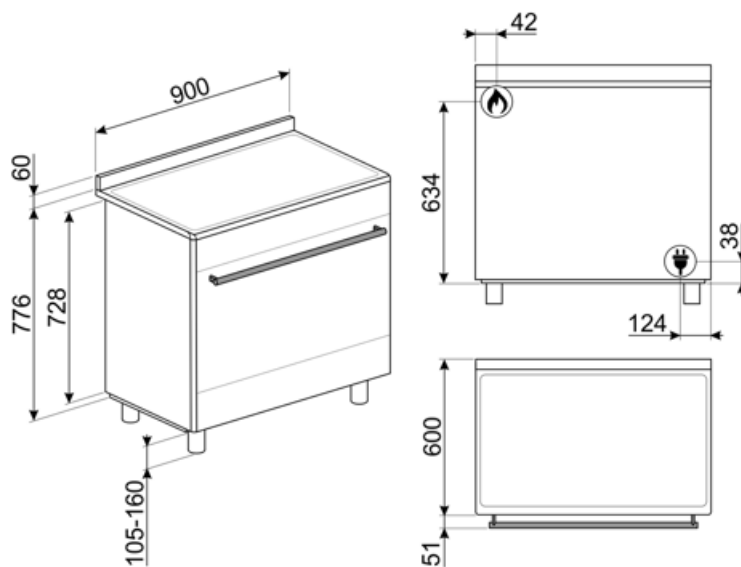

## Not included accessories

### AIRFRY9

Air fryer rack AIRFRY . Ideal for recreating traditional frying in the oven, but with fewer calories and less fat. It allows you to cook quickly and simply dishes such as French fries, fried vegetables and fish, ensuring perfect browning and crispiness.



### BBQ9



### BN920

### GTP

\*\*Partially extractable telescopic guides (1 level)\*\* Extraction: 300 mm Material: Stainless steel AISI 430 polished



### KIT600SNL-9

Cover strip for hob back side, suitable for 90 cm Concert cookers



### KITH95

Height extension kit (950 mm), stainless steel



### PALPZ

Pizza shovel with fold away handle width: 315mm length : 325mm



### PPX6090-1

Stainless steel teppanyaki grill plate suitable for 90cm Concert cookers



### SMOLD

Set of 7 silicone moulds for ice creams, ice lollies, pralines, ice cubes or to portion food. Usable from -60°C to +230°C

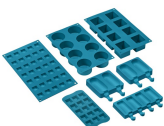

### AL90X9

Upstand suitable for 90 cm Concert cookers SX91



### BG6090-1

Cast iron grill plate suitable for Concert cookers



### BN940

### GTT

\*\*Totally extractable telescopic guides (1 level)\*\* Extraction: 433 mm Material: Stainless steel AISI 430 polished



### KIT90X9-1

Splash back, 90x60 cm, stainless steel, for Concert cookers



### KITPDQ

Height reduction feet (850 mm), stainless steel, for cookers



### PPR9

Refractory pizza stone without handles. Squared shaped stone: L64xH2,3xP37,5 cm Suitable also for gas ovens, to be put on the griddle.





















### SFLK1

Child lock



## Symbols glossary

 <p>Heavy duty cast iron pan stands: for maximum stability and strength.</p>	 <p>A: Product drying performance, measured from A+++ to D / G depending on the product family</p>
 <p>Installation in column: Installation in column</p>	 <p>Knobs control</p>
 <p>Air cooling system: to ensure a safe surface temperatures.</p>	 <p>Triple glazed doors: Number of glazed doors.</p>
 <p>Enamel interior: The enamel interior of all Smeg ovens have a special antacid lining which helps keep the interior clean by reducing the amount of cooking grease adhering to it.</p>	 <p>Fan assisted base: the mix of fan and lower heating element alone allows to finish cooking foods already cooked on the surface but not internally more quickly. This system is recommended to finish cooking foods that are already well cooked on the surface, but not internally, which therefore require a moderate higher heat. Ideal for any type of food.</p>
 <p>Fan with upper and lower elements: The elements combined with the fan aim to provide more uniform heat, a similar method to conventional cooking, so pre-heat is required. Most suitable for items requiring slow cooking methods.</p>	 <p>Upper and lower element only: a traditional cooking method best suited for single items located in the centre of the oven. the top pf the oven will always be hottest. Ideal for roast, fruit cakes, bread etc.</p>
 <p>Circulaire: The combination of the fan and circular element around it gives a hot air cooking method. This provides many benefits including no preheat if cook time is more than 20 minutes, no flavour transfer when cooking different foods at the same time, less energy, and shorter cook times. Good for all types of food.</p>	 <p>ECO: The combination of the grill, fan and lower element is particularly suitable for cooking small quantities of food.</p>
 <p>Grill element: Using of grill gives excellent results when cooking meat of medium and small portions, especially when combined with a rotisserie (where possible). Also ideal for cooking sausages and bacon.</p>	 <p>Half grill: For rapid cooking and browning of foods. Best results can be obtained by using the top shelf for small items, the lower shelves for larger ones, such as chops or sausages. For half grill heat is generated only at the centre of the element, so is ideal for smaller quantities.</p>
 <p>Fan with grill element: The fan reduces the fierce heat from the grill, providing an excellent method of grilling various foods, chops, steaks, sausages etc. giving even browning and heat distribution, without drying out the food. The top two levels recommended for use, and the lower part of the oven can be used to keep items warm at the same time, an excellent facility when cooking a grilled breakfast. Half grill (centre portion only) is ideal for small quantities of food.</p>	 <p>All glass inner door: All glass inner door, a single flat surface which is simple to keep clean.</p>
 <p>The inner door glass: can be removed with a few quick movements for cleaning.</p>	 <p>Side lights: Two opposing side lights increase visibility inside the oven.</p>



Automatic opening: some models have Automatic opening door when the cycle is finished which is a perfect solution for handle-less kitchen units as no handle is needed. For safety reasons, the door locks automatically when the machine is in use to avoid it being opened inadvertently.



The oven cavity has 5 different cooking levels.



Ultra rapid burners: Powerful ultra rapid burners offer up to 5kw of power.



Vapor Clean: a simple cleaning function using steam to loosen deposits in the oven cavity.



The capacity indicates the amount of usable space in the oven cavity in litres.

## Benefit

---

### **Gas hob**

Gas provides constant control of the heat source, with an immediate change in temperature

Equipped with a thermocouple, the gas supply is cut off if the flame is extinguished for greater safety

### **Vapor Clean**

By inserting water into a recess at the bottom of the cavity, steam is generated, which softens the residue and facilitates its removal

By inserting water into a recess at the bottom of the cavity, steam is generated, which softens the residue and facilitates its removal.

### **Buttons control**

Easy and intuitive timer setting with a simple buttons

### **Storage compartment**

More space thanks to the lower compartment, ideal for storing accessories or cooking utensils

### **Circulaire**

The best cooking performances guaranteed by ventilated circular flow.

Multiple fans and heating elements guarantee the perfect aerodynamic heat flow, allowing homogeneous and quicker cooking inside the cavity.

### **Multilevel cooking**

Several cooking levels allow maximum flexibility of use

### **Multilevel halogen light**

Internal halogen lighting on different levels guarantees excellent visibility

### **Removable inner glass**

Internal door glasses are easily removable for complete cleaning

### **Tangential cooling**

New cooling system with tangential fan and airflow from the door to the splashback

### **Isothermic Cavity**

The best cooking performance at the highest energy efficiency

### **BBQ (optional accessory)**

Barbeque cooking directly in the oven with the double-sided grill

**Pizza stone (optional accessory)**

Baking with refractory stone for soft and crispy pizza and yeast products (STONE optional accessory)

**Adjustable height**

Cooker top flushed with the working area thanks to adjustable feet

**Cold door**

During any function, the external door glass is cold, avoiding any risk of burns

**AirFry (AIRFRY optional accessory)**

Lighter and tastier food thanks to airfry basket

**Double Turbine**

The oven has two fans equipped with two circular heating elements allowing cooking with rotating heat