

SUK92MX9-1

Cooker size	90x60 cm
N. of cavities with energy label	2
Cavity heat source	Electric
Hob type	Gas
Type of main oven	Thermo-ventilated
Type of second oven	Static
Cleaning system main oven	Vapor Clean
EAN code	8017709282639
Energy efficiency class	A
Energy efficiency class, second cavity	A



Aesthetics



Aesthetics	Classic	Control knobs	Smeg Classic
Series	Concert	Controls colour	Stainless steel
Design	Standard	No. of controls	8
Colour	Stainless steel	Serigraphy colour	Black
Finishing	Brushed	Display	electronic 5 buttons
Command panel finish	Stainless steel	Door	With 2 horizontal strips
Logo	Embossed	Glass type	Stopsol
Logo position	Facia below the oven	Handle	Smeg Classic
Upstand	Yes	Handle Colour	Brushed stainless steel
Hob colour	Stainless steel	Storage compartment	Door
Type of pan stands	Cast Iron	Feet	Silver
Type of control setting	Control knobs	Plinth	Black

Programs / Functions

No. of cooking functions 6

Traditional cooking functions



Static

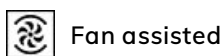

Fan assisted



Circulaire



ECO



Large grill

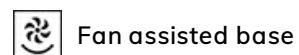

Fan assisted base

Cleaning functions



Vapor Clean

Programs / Functions Auxiliary Oven

Cooking functions cavity 2 4

Traditional cooking functions, cavity 2



Static



Small grill



Large grill

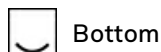

Bottom

Hob technical features

UR			
Total no. of cook zones 5			
Front left - Gas - Rapid - 3.00 kW			
Rear left - Gas - Semi Rapid - 1.80 kW			
Central - Gas - UR - 3.50 kW			
Rear right - Gas - Semi Rapid - 1.80 kW			
Front right - Gas - AUX - 1.00 kW			
Type of gas burners	Standard	Gas safety valves	Yes
Automatic electronic ignition	Yes	Burner caps	Matt black enamelled

Main Oven Technical Features



No. of lights	1	Removable inner door	Yes
Fan number	1	Total no. of door glasses	3
Net volume of the cavity	70 litres	No. of thermo-reflective door glasses	1
Gross volume, 1st cavity	79 l	Safety Thermostat	Yes
Cavity material	Easy clean enamel	Cooling system	Tangential
Shelf positions	5	Usable cavity space dimensions (HxWxD)	360X460X425 mm
Type of shelves	Metal racks	Temperature control	Electro-mechanical
Light type	Halogen	Lower heating element power	1200 W
Light power	40 W	Upper heating element - Power	1000 W
Cooking time setting	Start and Stop	Grill element	1700 W
Light when oven door is open	Yes	Circular heating element - Power	2000 W
Removable door	Yes	Grill type	Electric
Full glass inner door	Yes	Tilting grill	Yes

Options Main Oven

Timer	Yes	Minimum Temperature	50 °C
End of cooking acoustic alarm	Yes	Maximum temperature	260 °C

Second Oven Technical Features



Net volume of the second cavity	35 litres	No. total door glasses	3
Gross volume, 2nd cavity	36 l	No. thermo-reflective door glasses	1
Cavity material	Easy clean enamel	Safety Thermostat	Yes
Shelf positions	4	Cooling system	Tangential
Type of shelves	Metal racks	Usable cavity space dimensions (HxWxD)	311x206x418 mm
No. of lights	1	Temperature control	Electro-mechanical
Light type	Incandescent	Lower heating element - power	700 W
Light power	25 W	Upper heating element - Power	600 W
Removable door	Yes	Grill element - power	1300 W
Full glass inner door	Yes	Large grill - Power	1900 W
Removable inner door	Yes	Grill type	Electric

Options Auxiliary Oven

Minimum Temperature	50 °C	Maximum temperature	245 °C
---------------------	-------	---------------------	--------

Accessories included for Main Oven & Hob



Moka stand	1	Grill mesh	1
Chrome shelf with back and side stop	2	Telescopic Guide rails, partial Extraction	1
40mm deep tray	1		

Accessories included for Secondary Oven

Chrome shelf with back and side stop	1	Grill mesh	1
Wide baking tray	1		

Electrical Connection

Max Power Draw	4800 W	Power supply cable length	120 cm
Current	21 A	Additional connection modalities	Yes, Double and Three Phase
Voltage	220-240 V		
Voltage 2 (V)	380-415 V		

Type of electric cable Yes, Single phase

Frequency
Terminal block

50/60 Hz
5 poles

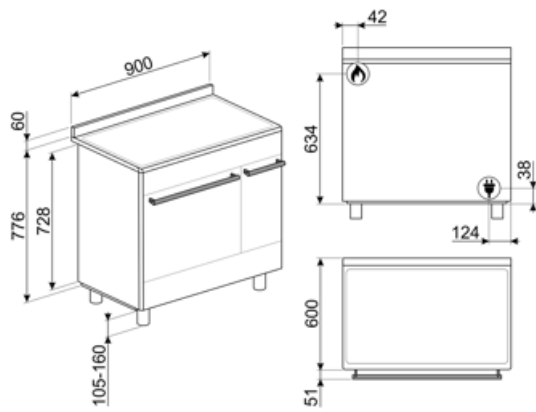

Not included accessories

AIRFRY

Air fryer rack AIRFRY . Ideal for recreating traditional frying in the oven, but with fewer calories and less fat. It allows you to cook quickly and simply dishes such as French fries, fried vegetables and fish, ensuring perfect browning and crispiness.



BBQ

Double sided plate BBQ. Suitable for recreating succulent and crispy dishes in the oven with the typical taste of grilled cooking. The ribbed side is particularly suitable for meats and cheeses. The smooth side for fish, seafood and vegetables.



BN620-1

Enamelled tray, 20mm deep



BNP608T

Teflon-coated tray, 8mm depth, to be placed on the grid



GTT

Totally extractable telescopic guides (1 level) Extraction: 433 mm Material: Stainless steel AISI 430 polished



KITPC92X9

Splash back, 90x60 cm, stainless steel, for Concert cookers, double pyrolytic cavity



PALPZ

Pizza shovel with fold away handle width: 315mm length : 325mm



SFLK1

Child lock



AL90X9

Upstand suitable for 90 cm Concert cookers SX91



BG6090-1

Cast iron grill plate suitable for Concert cookers



BN640

Enamelled tray, 40mm deep

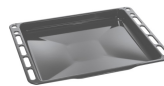

GTP

Partially extractable telescopic guides (1 level) Extraction: 300 mm Material: Stainless steel AISI 430 polished



KITH95

Height extension kit (950 mm), stainless steel



KITPDQ

Height reduction feet (850 mm), stainless steel, for cookers



PPX6090-1

Stainless steel teppanyaki grill plate suitable for 90cm Concert cookers



SMOLD

Set of 7 silicone moulds for ice creams, ice lollies, pralines, ice cubes or to portion food. Usable from -60°C to +230°C

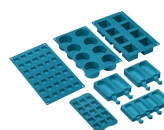























STONE

Rectangular refractory stone. Ideal for cooking pizzas with the same results as a typical wood-fired oven. Can also be used for baking bread, focaccias and other recipes such as pies, flans or biscuits Dimensions: L42 x H1,8 x P37,5 cm.



Symbols glossary

	Heavy duty cast iron pan stands: for maximum stability and strength.		A: Product drying performance, measured from A+++ to D / G depending on the product family
	Installation in column: Installation in column		Knobs control
	Air cooling system: to ensure a safe surface temperatures.		Triple glazed doors: Number of glazed doors.
	Enamel interior: The enamel interior of all Smeg ovens have a special antacid lining which helps keep the interior clean by reducing the amount of cooking grease adhering to it.		Fan assisted base: the mix of fan and lower heating element alone allows to finish cooking foods already cooked on the surface but not internally more quickly. This system is recommended to finish cooking foods that are already well cooked on the surface, but not internally, which therefore require a moderate higher heat. Ideal for any type of food.
	Fan with upper and lower elements: The elements combined with the fan aim to provide more uniform heat, a similar method to conventional cooking, so pre-heat is required. Most suitable for items requiring slow cooking methods.		Upper and lower element only: a traditional cooking method best suited for single items located in the centre of the oven. the top pf the oven will always be hottest. Ideal for roast, fruit cakes, bread etc.
	Lower heating element only: This function is ideal for foods that require extra base temperature without browning, e.g. pastry dishes, pizza. Also suitable for slow cooking of stews and casseroles.		Circulaire: The combination of the fan and circular element around it gives a hot air cooking method. This provides many benefits including no preheat if cook time is more than 20 minutes, no flavour transfer when cooking different foods at the same time, less energy, and shorter cook times. Good for all types of food.
	ECO: The combination of the grill, fan and lower element is particularly suitable for cooking small quantities of food.		Grill element: Using of grill gives excellent results when cooking meat of medium and small portions, especially when combined with a rotisserie (where possible). Also ideal for cooking sausages and bacon.
	Half grill: For rapid cooking and browning of foods. Best results can be obtained by using the top shelf for small items, the lower shelves for larger ones, such as chops or sausages. For half grill heat is generated only at the centre of the element, so is ideal for smaller quantities.		Light
	All glass inner door: All glass inner door, a single flat surface which is simple to keep clean.		The inner door glass: can be removed with a few quick movements for cleaning.
	Side lights: Two opposing side lights increase visibility inside the oven.		The oven cavity has 4 different cooking levels.
	The oven cavity has 5 different cooking levels.		Telescopic rails: allow you to pull out the dish and check it without having to remove it from the oven entirely.



Electronic control: Allows you to maintain temperature inside the oven with the precision 2-3 ° C. This enables to cook meals that are very sensitive to temperature changes, such as cakes, souffles, puddings.



Ultra rapid burners: Powerful ultra rapid burners offer up to 5kw of power.



The capacity indicates the amount of usable space in the oven cavity in litres.



Tilting grill: the tilting grill can be easily unhooked to move the heating element and clean the roof of the appliance in one simple step.



Vapor Clean: a simple cleaning function using steam to loosen deposits in the oven cavity.



The capacity indicates the amount of usable space in the oven cavity in litres.

Benefit

Gas hob

Gas provides constant control of the heat source, with an immediate change in temperature

Equipped with a thermocouple, the gas supply is cut off if the flame is extinguished for greater safety

Vapor Clean

By inserting water into a recess at the bottom of the cavity, steam is generated, which softens the residue and facilitates its removal

By inserting water into a recess at the bottom of the cavity, steam is generated, which softens the residue and facilitates its removal.

Buttons control

Easy and intuitive timer setting with a simple buttons

Storage compartment

More space thanks to the lower compartment, ideal for storing accessories or cooking utensils

Circulaire

The best cooking performances guaranteed by ventilated circular flow.

Multiple fans and heating elements guarantee the perfect aerodynamic heat flow, allowing homogeneous and quicker cooking inside the cavity.

Multilevel cooking

Several cooking levels allow maximum flexibility of use

Multilevel halogen light

Internal halogen lighting on different levels guarantees excellent visibility

Removable inner glass

Internal door glasses are easily removable for complete cleaning

Tangential cooling

New cooling system with tangential fan and airflow from the door to the splashback

Telescopic guides

Easy extraction and safe insertion of trays into the oven thanks to telescopic guides

AirFry (AIRFRY optional accessory)

Lighter and tastier food thanks to airfry basket

Cold door

During any function, the external door glass is cold, avoiding any risk of burns

Adjustable height

Cooker top flushed with the working area thanks to adjustable feet

Pizza stone (optional accessory)

Baking with refractory stone for soft and crispy pizza and yeast products (STONE optional accessory)

BBQ (optional accessory)

Barbeque cooking directly in the oven with the double-sided grill

Isothermic Cavity

The best cooking performance at the highest energy efficiency

Single turbine

The oven has a fan equipped with a circular heating element allowing cooking with rotating heat