

TR90DGM9

Cooker size	90x60 cm
N. of cavities with energy label	1
Cavity heat source	Electric
Hob type	Gas
Type of main oven	Thermo-ventilated
Cleaning system main oven	Catalytic
EAN code	8017709268435
Energy efficiency class	A

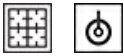

Aesthetics











Aesthetics	Victoria	Type of control setting	Control knobs
Series	Divina Cucina	Control knobs	Smeg Victoria
Design	Victoria	Controls colour	Stainless steel
Colour	Decorated / Special	No. of controls	8
Finishing	Gloss	Serigraphy colour	Silver
Command panel finish	Enamelled metal	Display	electronic 5 buttons
Decoration / Special colour	Maiolica	Door	With frame
Collaborations	Smeg & Dolce&Gabbana	Glass type	Black
Logo	assembled 50's	Handle	Smeg Victoria
Logo position	Upstand+ Command panel	Handle Colour	Polished chrome
Upstand	Yes	Storage compartment	Drawer
Hob colour	Black enamel	Feet	none
Type of pan stands	Cast Iron	Plinth	Anthracite

Programs / Functions

No. of cooking functions	9
--------------------------	---

Traditional cooking functions

 Static	 Fan assisted	 Circulaire
 ECO	 Large grill	 Fan grill (large)
 Base	 Fan assisted base	 Rotisserie

Other functions

 Defrost by time
--











Cleaning functions

Catalytic	 Vapor Clean
-----------	---

Hob technical features

			
Total no. of cook zones	5		
Front left - Gas - Rapid	2.90 kW		
Rear left - Gas - Semi Rapid	1.80 kW		
Central - Gas - 2UR (dual)	5.00 kW		
Rear right - Gas - Semi Rapid	1.80 kW		
Front right - Gas - AUX	1.00 kW		
Type of gas burners	Standard	Gas safety valves	Yes
Automatic electronic ignition	Yes	Burner caps	Matt black enamelled

Main Oven Technical Features

									
No. of lights	2	Removable inner door	Yes						
Fan number	2	Total no. of door glasses	3						
Net volume of the cavity	115 litres	No. of thermo-reflective door glasses	2						
Gross volume, 1st cavity	129 l	Safety Thermostat	Yes						
Cavity material	Easy clean enamel	Cooling system	Tangential						
Shelf positions	5	Usable cavity space dimensions (HxWxD)	371x724x418 mm						
Type of shelves	Metal racks	Temperature control	Electro-mechanical						
Light type	Halogen	Lower heating element power	1700 W						
Light power	40 W	Upper heating element - Power	1200 W						
Cooking time setting	Start and Stop	Grill element	1700 W						
Light when oven door is open	Yes	Large grill - Power	2900 W						
Door opening	Flap down								
Removable door	Yes								
Full glass inner door	Yes								

Circular heating element	2 x 1550 W
- Power	
Grill type	Electric
Soft Close system	Yes

Options Main Oven

Timer	Yes	Minimum Temperature	50 °C
End of cooking acoustic alarm	Yes	Maximum temperature	260 °C

Accessories included for Main Oven & Hob

Cast iron wok support	1	40mm deep tray	1
Moka stand in cast iron	1	Grill mesh	1
Chrome shelf with back and side stop	1	Catalytic panels	3
20mm deep tray	1		

Electrical Connection

Max Power Draw	3200 W	Power supply cable length	120 cm
Current	14 A	Frequency	50/60 Hz
Voltage	220-240 V	Terminal block	3 poles
Voltage 2 (V)	380-415 V		

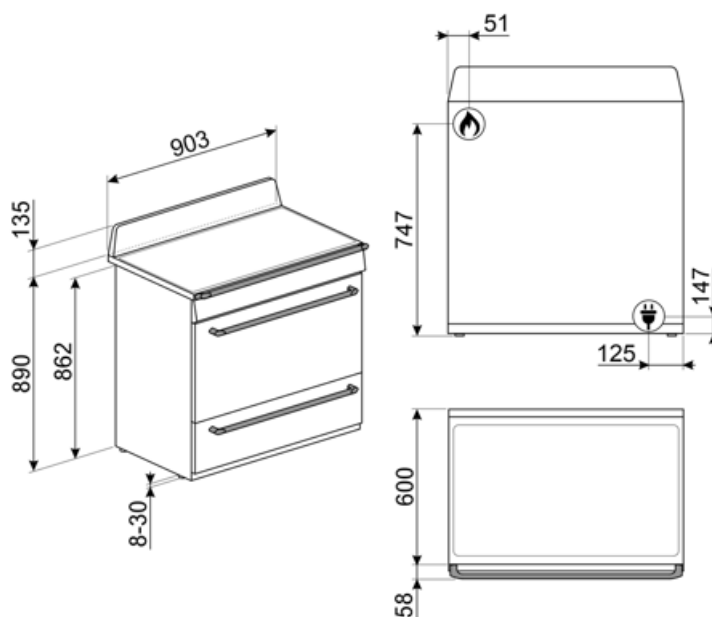

Not included accessories

AIRFRY9

Air fryer rack AIRFRY . Ideal for recreating traditional frying in the oven, but with fewer calories and less fat. It allows you to cook quickly and simply dishes such as French fries, fried vegetables and fish, ensuring perfect browning and crispiness.



BGTR9

Cast iron grill plate suitable for 90 cm and 100cm Victoria, 60 and 90cm Master and Symphony cookers



BN940

GTT

Totally extractable telescopic guides (1 level) Extraction: 433 mm Material: Stainless steel AISI 430 polished



KITHTR90

Height extension kit (950 mm), suitable for Victoria TR90 cookers



PALPZ

Pizza shovel with fold away handle width: 315mm length : 325mm



SMOLD

Set of 7 silicone moulds for ice creams, ice lollies, pralines, ice cubes or to portion food. Usable from -60°C to +230°C

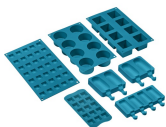

BBQ9



BN920

GTP

Partially extractable telescopic guides (1 level) Extraction: 300 mm Material: Stainless steel AISI 430 polished



KIT1TR9N

Splashback, 90x75 cm suitable for TR9 Victoria cookers, black



KITROT9

Rotisserie kit for 90x60 cookers, new cavity (115 L)





























PPR9

Refractory pizza stone without handles. Squared shaped stone: L64xH2,3xP37,5 cm Suitable also for gas ovens, to be put on the griddle.



Symbols glossary

 <p>Heavy duty cast iron pan stands: for maximum stability and strength.</p>	 <p>Catalytic cleaning: the system ensures perfect hygiene inside the oven thanks to the three self-cleaning panels coated with a special enamel that promotes the progressive elimination of traces of grease and odors caused by cooking.</p>
 <p>A: Product drying performance, measured from A+++ to D / G depending on the product family</p>	 <p>Installation in column: Installation in column</p>
 <p>Knobs control</p>	 <p>Air cooling system: to ensure a safe surface temperatures.</p>
 <p>Defrost by time: with this function the time of thawing of foods are determined automatically.</p>	 <p>Triple glazed doors: Number of glazed doors.</p>
 <p>Enamel interior: The enamel interior of all Smeg ovens have a special antacid lining which helps keep the interior clean by reducing the amount of cooking grease adhering to it.</p>	 <p>Fan assisted base: the mix of fan and lower heating element alone allows to finish cooking foods already cooked on the surface but not internally more quickly. This system is recommended to finish cooking foods that are already well cooked on the surface, but not internally, which therefore require a moderate higher heat. Ideal for any type of food.</p>
 <p>Fan with upper and lower elements: The elements combined with the fan aim to provide more uniform heat, a similar method to conventional cooking, so pre-heat is required. Most suitable for items requiring slow cooking methods.</p>	 <p>Upper and lower element only: a traditional cooking method best suited for single items located in the centre of the oven. the top pf the oven will always be hottest. Ideal for roast, fruit cakes, bread etc.</p>
 <p>Lower heating element only: This function is ideal for foods that require extra base temperature without browning, e.g. pastry dishes, pizza. Also suitable for slow cooking of stews and casseroles.</p>	 <p>Circulaire: The combination of the fan and circular element around it gives a hot air cooking method. This provides many benefits including no preheat if cook time is more than 20 minutes, no flavour transfer when cooking different foods at the same time, less energy, and shorter cook times. Good for all types of food.</p>
 <p>ECO: The combination of the grill, fan and lower element is particularly suitable for cooking small quantities of food.</p>	 <p>Grill element: Using of grill gives excellent results when cooking meat of medium and small portions, especially when combined with a rotisserie (where possible). Also ideal for cooking sausages and bacon.</p>
 <p>Fan with grill element: The fan reduces the fierce heat from the grill, providing an excellent method of grilling various foods, chops, steaks, sausages etc. giving even browning and heat distribution, without drying out the food. The top two levels recommended for use, and the lower part of the oven can be used to keep items warm at the same time, an excellent facility when cooking a grilled breakfast. Half grill (centre portion only) is ideal for small quantities of food.</p>	 <p>Rotisserie: The rotisserie (where installed) works in combination with the grill element to brown foods to perfection.</p>

-
- | | |
|--|--|
|  <p>All glass inner door: All glass inner door, a single flat surface which is simple to keep clean.</p> |  <p>The inner door glass: can be removed with a few quick movements for cleaning.</p> |
|  <p>Side lights: Two opposing side lights increase visibility inside the oven.</p> |  <p>Automatic opening: some models have Automatic opening door when the cycle is finished which is a perfect solution for handle-less kitchen units as no handle is needed. For safety reasons, the door locks automatically when the machine is in use to avoid it being opened inadvertently.</p> |
|  <p>The oven cavity has 5 different cooking levels.</p> |  <p>Soft close: all models are equipped with advanced function of smooth closing of the door, which allows the device to close smoothly and quietly.</p> |
|  <p>Ultra rapid burners: Powerful ultra rapid burners offer up to 5kw of power.</p> |  <p>Vapor Clean: a simple cleaning function using steam to loosen deposits in the oven cavity.</p> |
|  <p>The capacity indicates the amount of usable space in the oven cavity in litres.</p> | |

Benefit

Gas hob

Gas provides constant control of the heat source, with an immediate change in temperature

Equipped with a thermocouple, the gas supply is cut off if the flame is extinguished for greater safety

Catalysis

Easy oven cleaning through the use of catalytic panels in the cavity

This permanent process allows continuous cleaning and degreasing of the three cavity walls, starting its grease oxidation phase when the oven reaches 200°C.

Buttons control

Easy and intuitive timer setting with a simple buttons

Drawer storage compartment

More space thanks to the lower compartment, ideal for storing accessories or cooking utensils

Circulaire

The best cooking performances guaranteed by ventilated circular flow.

Multiple fans and heating elements guarantee the perfect aerodynamic heat flow, allowing homogeneous and quicker cooking inside the cavity.

Multilevel cooking

Several cooking levels allow maximum flexibility of use

Multilevel halogen light

Internal halogen lighting on different levels guarantees excellent visibility

Removable inner glass

Internal door glasses are easily removable for complete cleaning

Tangential cooling

New cooling system with tangential fan and airflow from the door to the splashback

Isothermic Cavity

The best cooking performance at the highest energy efficiency

Cold door

During any function, the external door glass is cold, avoiding any risk of burns

AirFry (AIRFRY optional accessory)

Lighter and tastier food thanks to airfry basket

BBQ (optional accessory)

Barbeque cooking directly in the oven with the double-sided grill

Pizza stone (optional accessory)

Baking with refractory stone for soft and crispy pizza and yeast products (STONE optional accessory)

Adjustable height

Cooker top flushed with the working area thanks to adjustable feet

Soft close

The door is equipped with a specific system for silent closing

Double Turbine

The oven has two fans equipped with two circular heating elements allowing cooking with rotating heat