

TR90GMBLNL

Categorie fornuis	90x60 cm
Aantal ovens met energielabel	1
Cavity heat source	Elektrisch
Type kookplaat	Gas
Type primaire oven	Thermogeventileerd
Reinigingssysteem primaire oven	Vapor Clean
EAN-code	8017709345099
Energie-efficiëntieklasse	A



Design

			
Esthetiek	Victoria	Kleur knoppen	Roestvrij staal
Design	Victoria	Aantal bedieningsknoppen	8
Kleur	Zwart	Kleur serigrafie	Zilver
Afwerking	Glanzend	Display	Elektronisch 5 toetsen
Afwerking bedieningspaneel	Gekleurd plaatstaal	Deur	Met kader
Logo	assembled 50's	Type glas	Zwart
Positie logo	Upstand+ Bedieningspaneel	Handgreep	Smeg Victoria
Upstand	Ja	Kleur handgreep	Glanzend chroom
Kleur kookplaat	Zwart glanzend	Opbergruimte	Push pull
Type pannendragers	Gietijzer	Pootjes	Geen
Type bediening	Bedieningsknoppen	Plint	Antraciet
Bedieningsknoppen	Smeg Victoria		

Programma's / functies

Aantal kookfuncties	9
---------------------	---

Traditionele kookfuncties

 Statisch	 Geventileerd	 Circulaire
 ECO	 Kleine grill	 Grote vlak-grill
 Fan grill (large)	 Base	 Fan assisted base

Overige functies

 Ontdooien op tijd

Schoonmaak functie











Katalytisch

 Vapor Clean

Technische specificaties kookplaat

			
Totaal aantal kookzones 5			
Linksvoor - Gas - RP - 3 kW			
Linksachter - Gas - SRD - 1.80 kW			
Midden - Gas - 2URP (dual) - 5.10 kW			
Rechtsachter - Gas - SRD - 1.80 kW			
Rechtsvoor - Gas - AUX - 1.00 kW			
Type gasbranders	Standaard	Thermobeveiliging	Ja
Automatische vonkontsteking	Ja	Branderdeksels	Mat zwart geëmailleerd

Technische specificaties primaire oven

         			
Aantal lampen	2	Uitneembaar glas binnendeur	Ja
Aantal ventilatoren	2	Aantal ruiten ovendeur	3
Netto inhoud	115 l	Aantal thermo-reflecterende ruiten	2
Bruto inhoud 1e oven	129 l	Veiligheidsthermostaat	Ja
Materiaal ovenruimte	Ever Clean emaille	Koelsysteem	Mantelkoeling
Aantal kookniveaus	5	Afmetingen bruikbare interne ovenruimte (hxbxd)	371x724x418 mm
Type ovenrekken	Metalen zijsteunen	Temperatuurregeling	Elektro-mechanisch
Soort verlichting	Halogeen	Onderwarmte - vermogen	1700 W
Vermogen lamp	40 W	Bovenwarmte - vermogen	1200 W
Instelling kooktijd	Start en stop		
Automatische inschakeling verlichting bij openen deur	Ja		
Deur openen	naar beneden		

Uitneembare ovendeur	Ja	Grill - vermogen	1700 W
Volledig glazen binnendeur	Ja	Grote vlakgrill - vermogen	2900 W
		Circulatie - vermogen	2 x 1550 W
		Type grill	Elektrisch
		Soft close systeem	Ja

Opties primaire oven

Timer	Ja	Minimum temperatuur	50 °C
Akoestisch signaal einde kooktijd	Ja	Maximum temperatuur	260 °C

Meegeleverde accessoires primaire oven en kookplaat

Gietijzeren wokring	1	Bakplaat (20 mm)	1
Gietijzeren houder t.b.v. caffettiera	1	Bakplaat (40 mm)	1
Rek met achter- en zijstop	1	Inzetrooster	1

Elektrische aansluiting

Aansluitwaarde	3200 W	Lengte voedingskabel	120 cm
Stroom	14 A	Frequentie	50/60 Hz
Spanning	220-240 V	Aansluitkast	3 polig
Electric cable	Installed, Single phase		

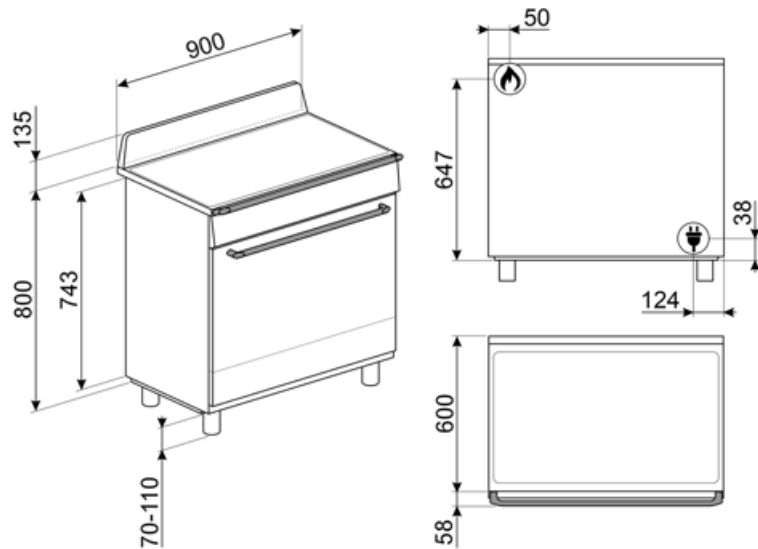

Accessoires niet inbegrepen

AIRFRY9

Air fryer rack AIRFRY . Ideal for recreating traditional frying in the oven, but with fewer calories and less fat. It allows you to cook quickly and simply dishes such as French fries, fried vegetables and fish, ensuring perfect browning and crispiness.



BGTR9

Gietijzeren grillplaat geschikt voor 90 cm en 100 cm Victoria



BN940

GTT

Volledig uittrekbare telescopische geleiders (1 niveau)



KITH95CPF9

Height extension kit with plinth, (950mm), three sides, black with feet, suitable for CPF9 Portofino and Sinfony C9 cookers



PPR9

Refractory pizza stone without handles. Squared shaped stone: L64xH2,3xP37,5 cm Suitable also for gas ovens, to be put on the griddle.



SMOLD

Set van 7 siliconen vormpjes voor ijsjes, ijslolly's, pralines, ijsblokjes of om etenswaren te portioneren. Bruikbaar van -60 ° C tot + 230 ° C

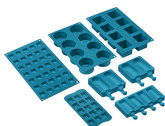

BBQ9



BN920

GTP

Gedeeltelijk uittrekbare telescopische geleiders (1 niveau)



KIT1TR9N

Splashback black, 90cm ,suitable for TR90 and TR93 Victoria cookers



PALPZ

Pizzaschep met inklapbare handgreep breedte: 315 mm lengte: 325 mm





























SFLK1

Kinderslot



Symbols glossary

 <p>A: Droogprestaties van het product, gemeten vanaf A +++ tot D / G afhankelijk van de productfamilie</p>	 <p>Heavy duty gietijzeren pannendragers: voor maximale stabiliteit en sterkte.</p>
 <p>Installation in column: Installation in column</p>	 <p>Luchtkoelsysteem: om een veilig oppervlak te garanderen temperaturen.</p>
 <p>Ontdooien op tijd: met deze functie wordt automatisch het tijdstip van ontdooien van voedsel bepaald</p>	 <p>Deuren met driedubbele beglazing: aantal glazen deuren.</p>
 <p>Geëmailleerde binnenkant: De geëmailleerde binnenkant van alle Smeg-ovens heeft een speciale antacidumvoering die helpt om de binnenkant schoon te houden door de hoeveelheid kookvet te verminderen.</p>	 <p>Fan assisted base: the mix of fan and lower heating element alone allows to finish cooking foods already cooked on the surface but not internally more quickly. This system is recommended to finish cooking foods that are already well cooked on the surface, but not internally, which therefore require a moderate higher heat. Ideal for any type of food.</p>
 <p>Ventilator met bovenste en onderste elementen: de elementen in combinatie met de ventilator zijn bedoeld om een meer gelijkmatige warmte te bieden, een methode die vergelijkbaar is met conventioneel koken, dus voorverwarmen is vereist. Het meest geschikt voor items die langzaam koken vereisen.</p>	 <p>De ovenruimte wordt tegelijk door het onder- en bovenelement verwarmt. De hitteverdeling over het gerecht is afhankelijk van het niveau waarop men dit plaatst. Geschikt voor bakken op 1 niveau. Gerechten: alle ovenschotels, vlees, gevogelte, brood, (gevulde) taarten. Speciaal: gans en eend (bevatten veel vet).</p>
 <p>De ovenruimte wordt uitsluitend verhit door het onderelement. Voor gerechten die een hoge basistemperatuur behoeven, heeft deze bakstand weinig tot geen invloed op de korst aan de bovenzijde. Geschikt voor bakken op 1 niveau, ideaal voor deeggerechten die moeten rijzen (bijv. pizza). Bij gevulde taarten zal de deegbodem beter droog blijven.</p>	 <p>Circulaire: it is the perfect function for cooking all types of dishes in a more delicate way. The heat comes from the back of the oven and is distributed quickly and evenly The fan is active. It is also ideal for cooking on multiple levels without mixing smells and flavors.</p>
 <p>ECO: low energy consumption cooking: this function is particularly suitable for cooking on a single shelf with low energy consumption. It is recommended for all types of food except those that can generate a lot of moisture (for example vegetables). To achieve maximum energy savings and reduce time, it is recommended to put the food in the oven without preheating the cooking compartment</p>	 <p>De warmte wordt geproduceerd door het grill- en bovenelement. Verhitting over het volledige oppervlak. De thermostaat wordt, afhankelijk van het gerecht, in de regel op de maximale stand gezet. Bij een korte baktijd kan de oven deur gesloten blijven; bij langere baktijd blijft deze gedeeltelijk geopend. Voor vleesgerechten (klein- en middelgroot), vleespennen, vis, groenten, gratineren etc.</p>

-  De warmte is alleen afkomstig van het grill-element. Verhitting over een kleiner oppervlak. Te gebruiken als de grote vlak-grill, maar voor kleinere hoeveelheden
-  Ventilator met grillelement: De ventilator vermindert de felle hitte van de grill en biedt een uitstekende methode om verschillende soorten voedsel, karbonades, steaks, worstjes enz. Te grillen, waardoor het gelijkmatig bruin wordt en de warmte wordt verdeeld, zonder het voedsel uit te drogen. De bovenste twee niveaus die voor gebruik worden aanbevolen, en het onderste deel van de oven kunnen worden gebruikt om gerechten tegelijkertijd warm te houden, een uitstekende mogelijkheid bij het bereiden van een gegrild ontbijt. Halve grill (alleen middengedeelte) is ideaal voor kleine hoeveelheden voedsel.
-  All glass inner door: All glass inner door, a single flat surface which is simple to keep clean.
-  The inner door glass: can be removed with a few quick movements for cleaning.
-  verlichting
-  Automatic opening: some models have Automatic opening door when the cycle is finished which is a perfect solution for handle-less kitchen units as no handle is needed. For safety reasons, the door locks automatically when the machine is in use to avoid it being opened inadvertently.
-  The oven cavity has 5 different cooking levels.
-  Soft close: all models are equipped with advanced function of smooth closing of the door, which allows the device to close smoothly and quietly.
-  Ultrasnelle branders: Krachtige ultrasnelle branders bieden tot 5kw vermogen.
-  Vapor Clean: a simple cleaning function using steam to loosen deposits in the oven cavity.
-  The capacity indicates the amount of usable space in the oven cavity in litres.
-  Knobs control

Benefit (TT)

Gas hob

Gas provides permanent control of the heat source and the temperature change is immediate

Equipped with a thermocouple, the gas supply is cut off if the flame is extinguished for greater safety.

Vapor Clean

By inserting water into a recess at the bottom of the cavity, steam is generated, which softens the residue and facilitates its removal

By inserting water into a recess at the bottom of the cavity, steam is generated, which softens the residue and facilitates its removal.

Buttons control

Easy and intuitive timer setting with a simple buttons

Push-pull storage compartment

More space thanks to the lower push-pull compartment, ideal for storing accessories or cooking utensils

True-convection

The best cooking performances guaranteed by ventilated circular flow

Multiple fans and heating elements guarantee the perfect aerodynamic heat flow, allowing homogeneous and quicker cooking inside the cavity.

Multilevel cooking

Several cooking levels allow maximum flexibility of use

Multilevel halogen light

Internal halogen lighting on different levels guarantees excellent visibility

Removable inner glass

Internal door glasses are easily removable for complete cleaning

Tangential cooling

New cooling system with tangential fan and airflow from the door to the splashback

Isothermic Cavity

The best cooking performance at the highest energy efficiency

BBQ (optional accessory)

Barbeque cooking directly in the oven with the double-sided grill (BBQ optional accessory)

Pizza stone (optional accessory)

Baking with refractory stone for soft and crispy pizza and yeast products (STONE optional accessory)

Adjustable height

Cooker top flushed with the working area thanks to adjustable feet

Cold door

During any function, the external door glass is cold, avoiding any risk of burns

AirFry (AIRFRY optional accessory)

Lighter and tastier food thanks to airfry basket (optional accessory)

Soft close

The door is equipped with a specific system for silent closing

Double Turbine

The oven has two fans equipped with two circular heating elements allowing cooking with rotating heat

Catalysis

Easy oven cleaning through the use of catalytic panels in the cavity

This permanent process allows continuous cleaning and degreasing of the three cavity walls, starting its grease oxidation phase when the oven reaches 200°C.