

TR90IMP

Categorie fornuis	90x60 cm
Aantal ovens met energielabel	1
Cavity heat source	Elektrisch
Type kookplaat	Inductie
Type primaire oven	Thermogeventileerd
Reinigingssysteem primaire oven	Vapor Clean
EAN-code	8017709344764
Energie-efficiëntieklasse	A



Design

			
Esthetiek	Victoria	Kleur knoppen	Roestvrij staal
Design	Victoria	Aantal bedieningsknoppen	7
Kleur	Crème	Kleur serigrafie	Zwart
Afwerking	Glanzend	Display	Elektronisch 5 toetsen
Afwerking bedieningspaneel	Gekleurd plaatstaal	Deur	Met kader
Logo	assembled 50's	Type glas	Zwart
Positie logo	Upstand+ Bedieningspaneel	Handgreep	Smeg Victoria
Upstand	Ja	Kleur handgreep	Glanzend chroom
Kleur kookplaat	Zwart glanzend	Opbergruimte	Push pull
Type bediening	Bedieningsknoppen	Pootjes	Geen
Slider	Rood	Plint	Zwart
Bedieningsknoppen	Smeg Victoria		

Programma's / functies

Aantal kookfuncties	9
---------------------	---

Traditionele kookfuncties

 Statisch	 Geventileerd	 Circulaire
 ECO	 Kleine grill	 Grote vlak-grill
 Fan grill (large)	 Base	 Fan assisted base



Overige functies

 Ontdooien op tijd

Schoonmaak functie

 Vapor Clean

Opties kookplaat

			
Kinderbeveiliging	Ja	ECO-Logic optie - stappen	3700, 4800, 7400 W
ECO-Logic optie	Ja		

Technische specificaties kookplaat



Totaal aantal kookzones 5

Linksvoor - Inductie - enkel - 1.30 kW - Booster 1.40 kW - Ø 18.0 cm

Linksachter - Inductie - enkel - 2.30 kW - Booster 3.00 kW - Ø 21.0 cm

Midden - Inductie - enkel - 2.30 kW - Booster 3.00 kW - Ø 27.0 cm

Rechtsachter - Inductie - enkel - 1.30 kW - Booster 1.40 kW - Ø 18.0 cm

Rechtsvoor - Inductie - enkel - 2.30 kW - Booster 3.00 kW - Ø 21.0 cm

Automatische stop bij oververhitting	Ja	Indicator minimaal te gebruiken diameter	Ja
Automatische aanpassing panafmeting	Ja	Indicator geselecteerde zone	Ja

Technische specificaties primaire oven



Aantal lampen	2	Uitneembaar glas binnendeur	Ja
Aantal ventilatoren	2	Aantal ruiten ovendeur	3
Netto inhoud	115 l	Aantal thermo-reflecterende ruiten	2
Bruto inhoud 1e oven	129 l		
Materiaal ovenruimte	Ever Clean emaille		

Aantal kookniveaus	5	Veiligheidsthermostaat	Ja
Type ovenrekken	Metalen zijsteunen	Koelsysteem	Mantelkoeling
Soort verlichting	Halogeen	Afmetingen bruikbare interne ovenruimte (hxbxd)	371x724x418 mm
Vermogen lamp	40 W	Temperatuurregeling	Elektro-mechanisch
Instelling kooktijd	Start en stop	Onderwarmte - vermogen	1700 W
Automatische inschakeling verlichting bij openen deur	Ja	Bovenwarmte - vermogen	1200 W
Deur openen	naar beneden	Grill - vermogen	1700 W
Uitneembare ovendeur	Ja	Grote vlakgrill - vermogen	2900 W
Volledig glazen binnendeur	Ja	Circulatie - vermogen	1550 W
		Type grill	Elektrisch
		Soft close systeem	Ja

Opties primaire oven

Timer	Ja	Minimum temperatuur	50 °C
Akoestisch signaal einde kooktijd	Ja	Maximum temperatuur	260 °C

Meegeleverde accessoires primaire oven en kookplaat



Rek met achter- en zijstop	1	Inzetrooster	1
Bakplaat (20 mm)	1	Telescopische geleiders, gedeeltelijk uitschuifbaar	1
Bakplaat (40 mm)	1		

Elektrische aansluiting

Aansluitwaarde	10600 W	Electric cable	Installed, Single phase
Stroom	46 A	Type stroomkabel	Double and Three Phase
Spanning	220-240 V	Frequentie	50/60 Hz
Spanning 2 (V)	380-415 V	Aansluitkast	5 polig

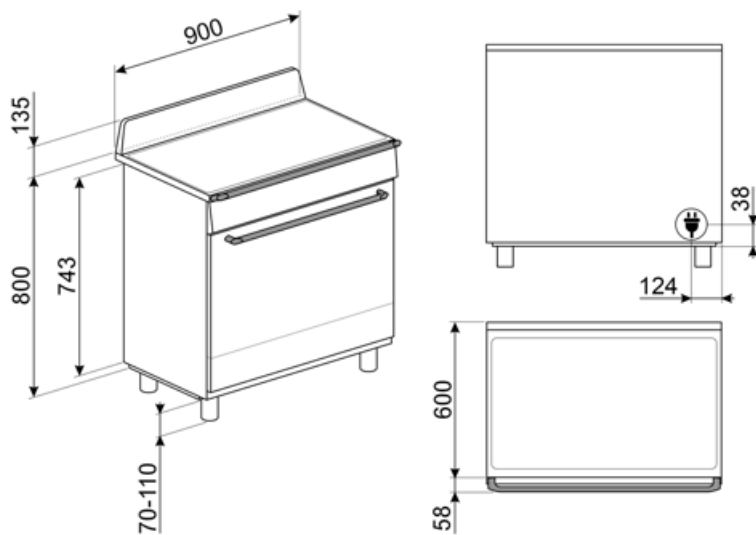

Accessoires niet inbegrepen

AIRFRY9

Air fryer rack AIRFRY . Ideal for recreating traditional frying in the oven, but with fewer calories and less fat. It allows you to cook quickly and simply dishes such as French fries, fried vegetables and fish, ensuring perfect browning and crispiness.



BN920

GRILLPLATE

Universal griddle for induction, gas, ceramic and electric hobs. Non-stick surface ideal for cooking meat, cheese and vegetables. Dimensions: 410 x 240 mm.



GTT

Volledig uittrekbare telescopische geleiders (1 niveau)



KITH95CPF9

Height extension kit with plinth, (950mm), three sides, black with feet, suitable for CPF9 Portofino and Sinfony C9 cookers

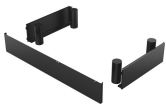

PPR9

Refractory pizza stone without handles. Squared shaped stone: L64xH2,3xP37,5 cm Suitable also for gas ovens, to be put on the griddle.



SFLK1

Kinderslot



TPKPLATE

Universal plate for induction, gas, ceramic and electric hobs. Non-stick surface ideal for cooking fish, eggs and vegetables. Dimensions: 410 X 240 mm.



BBQ9



BN940

GTP

Gedeeltelijk uittrekbare telescopische geleiders (1 niveau)



KIT1TR9N

Splashback black, 90cm ,suitable for TR90 and TR93 Victoria cookers



PALPZ

Pizzaschep met inklapbare handgreep breedte: 315 mm lengte: 325 mm



SCRP

Inductie- en keramische kookplaten en teppanyaki-schraper



SMOLD

Set van 7 siliconen vormpjes voor ijsjes, ijslolly's, pralines, ijsblokjes of om etenswaren te portioneren. Bruikbaar van -60 ° C tot + 230 ° C

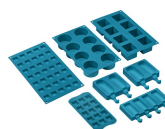

Alternative products































TR90IMBL
Kleur: Zwart



TR90IMGR
Kleur: Lei Grijs

Symbols glossary

 <p>Kinderslot: sommige modellen zijn voorzien van een apparaat om het programma / de cyclus te vergrendelen zodat het niet kan per ongeluk veranderd</p>	 <p>A: Droogprestaties van het product, gemeten vanaf A +++ tot D / G afhankelijk van de productfamilie</p>
 <p>Installation in column: Installation in column</p>	 <p>Knobs control</p>
 <p>Luchtkoelsysteem: om een veilig oppervlak te garanderen temperaturen.</p>	 <p>Ontdooien op tijd: met deze functie wordt automatisch het tijdstip van ontdooien van voedsel bepaald</p>
 <p>Deuren met driedubbele beglazing: aantal glazen deuren.</p>	 <p>ECO-logic: optie stelt u in staat om de vermogenslimiet van de werkelijke energiebesparing van het apparaat te beperken</p>
 <p>Geëmailleerde binnenkant: De geëmailleerde binnenkant van alle Smeg-ovens heeft een speciale antacidumvoering die helpt om de binnenkant schoon te houden door de hoeveelheid kookvet te verminderen.</p>	 <p>Fan assisted base: the mix of fan and lower heating element alone allows to finish cooking foods already cooked on the surface but not internally more quickly. This system is recommended to finish cooking foods that are already well cooked on the surface, but not internally, which therefore require a moderate higher heat. Ideal for any type of food.</p>
 <p>Ventilator met bovenste en onderste elementen: de elementen in combinatie met de ventilator zijn bedoeld om een meer gelijkmatige warmte te bieden, een methode die vergelijkbaar is met conventioneel koken, dus voorverwarmen is vereist. Het meest geschikt voor items die langzaam koken vereisen.</p>	 <p>De ovenruimte wordt tegelijk door het onder- en bovenelement verwarmt. De hitteverdeling over het gerecht is afhankelijk van het niveau waarop men dit plaatst. Geschikt voor bakken op 1 niveau. Gerechten: alle ovenschotels, vlees, gevogelte, brood, (gevulde) taarten. Speciaal: gans en eend (bevatten veel vet).</p>
 <p>De ovenruimte wordt uitsluitend verhit door het onderelement. Voor gerechten die een hoge basistemperatuur behoeven, heeft deze bakstand weinig tot geen invloed op de korst aan de bovenzijde. Geschikt voor bakken op 1 niveau, ideaal voor deeggerechten die moeten rijzen (bijv. pizza). Bij gevulde taarten zal de deegbodem beter droog blijven.</p>	 <p>Circulaire: it is the perfect function for cooking all types of dishes in a more delicate way. The heat comes from the back of the oven and is distributed quickly and evenly The fan is active. It is also ideal for cooking on multiple levels without mixing smells and flavors.</p>
 <p>ECO: low energy consumption cooking: this function is particularly suitable for cooking on a single shelf with low energy consumption. It is recommended for all types of food except those that can generate a lot of moisture (for example vegetables). To achieve maximum energy savings and reduce time, it is recommended to put the food in the oven without preheating the cooking compartment</p>	 <p>De warmte wordt geproduceerd door het grill- en bovenelement. Verhitting over het volledige oppervlak. De thermostaat wordt, afhankelijk van het gerecht, in de regel op de maximale stand gezet. Bij een korte baktijd kan de ovendeur gesloten blijven; bij langere baktijd blijft deze gedeeltelijk geopend. Voor vleesgerechten (klein- en middelgroot), vleespennen, vis, groenten, gratineren etc.</p>

-  De warmte is alleen afkomstig van het grill-element. Verhitting over een kleiner oppervlak. Te gebruiken als de grote vlak-grill, maar voor kleinere hoeveelheden
-  Overheat protection: The safety system that automatically turns off the hob in case of overheating of the control unit.
-  All glass inner door: All glass inner door, a single flat surface which is simple to keep clean.
-  verlichting
-  The oven cavity has 5 different cooking levels.
-  Telescopic rails: allow you to pull out the dish and check it without having to remove it from the oven entirely.
-  The capacity indicates the amount of usable space in the oven cavity in litres.
-  Ventilator met grillelement: De ventilator vermindert de felle hitte van de grill en biedt een uitstekende methode om verschillende soorten voedsel, karbonades, steaks, worstjes enz. Te grillen, waardoor het gelijkmatig bruin wordt en de warmte wordt verdeeld, zonder het voedsel uit te drogen. De bovenste twee niveaus die voor gebruik worden aanbevolen, en het onderste deel van de oven kunnen worden gebruikt om gerechten tegelijkertijd warm te houden, een uitstekende mogelijkheid bij het bereiden van een gegrild ontbijt. Halve grill (alleen middengedeelte) is ideaal voor kleine hoeveelheden voedsel.
-  Induction: The work of these hobs is based on the principle of electromagnetic induction. The heat is generated directly in the bottom of the pan during its contact with the hob.
-  The inner door glass: can be removed with a few quick movements for cleaning.
-  Automatic opening: some models have Automatic opening door when the cycle is finished which is a perfect solution for handle-less kitchen units as no handle is needed. For safety reasons, the door locks automatically when the machine is in use to avoid it being opened inadvertently.
-  Soft close: all models are equipped with advanced function of smooth closing of the door, which allows the device to close smoothly and quietly.
-  Vapor Clean: a simple cleaning function using steam to loosen deposits in the oven cavity.

Benefit (TT)

Induction hob

Induction offers fast cooking and precise temperature control

Through the use of suitable cookware, induction is easy to use and maintain, safe and responsive.

Vapor Clean

By inserting water into a recess at the bottom of the cavity, steam is generated, which softens the residue and facilitates its removal

By inserting water into a recess at the bottom of the cavity, steam is generated, which softens the residue and facilitates its removal.

Buttons control

Easy and intuitive timer setting with a simple buttons

Push-pull storage compartment

More space thanks to the lower push-pull compartment, ideal for storing accessories or cooking utensils

True-convection

The best cooking performances guaranteed by ventilated circular flow

Multiple fans and heating elements guarantee the perfect aerodynamic heat flow, allowing homogeneous and quicker cooking inside the cavity.

Multilevel cooking

Several cooking levels allow maximum flexibility of use

Multilevel halogen light

Internal halogen lighting on different levels guarantees excellent visibility

Removable inner glass

Internal door glasses are easily removable for complete cleaning

Tangential cooling

New cooling system with tangential fan and airflow from the door to the splashback

Telescopic guides

Easy extraction and safe insertion of trays into the oven thanks to telescopic guides

Isothermic Cavity

The best cooking performance at the highest energy efficiency

Adjustable height

Cooker top flushed with the working area thanks to adjustable feet

BBQ (optional accessory)

Barbeque cooking directly in the oven with the double-sided grill (BBQ optional accessory)

Pizza stone (optional accessory)

Baking with refractory stone for soft and crispy pizza and yeast products (STONE optional accessory)

Cold door

During any function, the external door glass is cold, avoiding any risk of burns

AirFry (AIRFRY optional accessory)

Lighter and tastier food thanks to airfry basket (optional accessory)

Soft close

The door is equipped with a specific system for silent closing

Double Turbine

The oven has two fans equipped with two circular heating elements allowing cooking with rotating heat