

# TRA93P

Cooker size	90x60 cm
N. of cavities with energy label	3
Hob type	Gas
Type of main oven	Thermoseal
Type of second oven	Fan assisted
Cleaning system main oven	Vapour Clean
EAN code	8017709184155

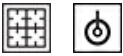

## Aesthetics



<b>Aesthetic</b>	Victoria	<b>Control knobs</b>	Smeg Victoria
<b>Design</b>	Victoria	<b>Controls colour</b>	Stainless steel
<b>Colour</b>	Cream	<b>No. of controls</b>	10
<b>Finishing</b>	Glossy	<b>Serigraphy colour</b>	Black
<b>Command panel finish</b>	Enamelled metal	<b>Display</b>	electronic 5 buttons
<b>Logo</b>	assembled 50's	<b>Door</b>	With frame
<b>Logo position</b>	Upstand	<b>Glass type</b>	Black
<b>Upstand</b>	Yes	<b>Handle</b>	Smeg Victoria
<b>Hob colour</b>	Black enamel	<b>Handle Colour</b>	Brushed stainless steel
<b>Type of pan stands</b>	Cast Iron	<b>Plinth</b>	Anthracite
<b>Type of control setting</b>	Control knobs		

## Programs / Functions

No. of cooking functions 5

Traditional cooking functions



Static



Fan assisted



Circulaire



Eco



Fan assisted bottom

Other functions

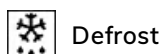

Defrost

## Cleaning functions

 Vapour Clean

## Programs / Functions Third Oven

No. of functions third oven

1

Oven light



Full grill



## Hob technical features

**UR**

Total no. of cook zones 6

Front right - Gas - Semi Rapid - 1.80 kW

Rear right - Gas - Rapid - 1.85 kW - Booster kW

Front centre - Gas - AUX - 1.00 kW

Rear centre - Gas - Semi Rapid - 1.30 kW - Booster kW

Rear left - Gas - AUX - 1.60 (BBQ) kW

Front left - Gas - UR - 4.20 kW

Type of gas burners Standard

Gas safety valves

Yes

Automatic electronic ignition Yes

Burner caps

Matt black enamelled

## Main Oven Technical Features



No. of lights

1

Net volume of the cavity 63 l

Gross volume, 1st cavity 68 l

Cavity material Ever Clean enamel

No. of shelves 4

Type of shelves Metal racks

Light type Halogen

Light Power 40 W

Cooking time setting Start and Stop

Door opening Side opening

Removable door Yes

Full glass inner door Yes

Removable inner door Yes

Total no. of door glasses 3

No. of thermo-reflective door glasses 1

Safety Thermostat Yes

Usable cavity space dimensions (HxWxD) 316x444x425 mm

Temperature control Electro-mechanical

Lower heating element power 1200 W

Upper heating element - Power 1000 W

Grill element 1700 W

Large grill - Power 2700 W

Circular heating element - Power 2000 W

Grill type Electric

Tilting grill Yes

## Options Main Oven

Timer	Yes	Minimum Temperature	50 °C
End of cooking acoustic alarm	Yes	Maximum temperature	260 °C

## Second Oven Technical Features



Net volume of the second cavity	66 l
Gross volume, 2nd cavity	68 l
Cavity material	Ever Clean enamel
No. of shelves	9
Type of shelves	Metal racks
No. of lights	1
Light type	Halogen
Light Power	40 W
Door opening	Side opening
Removable door	Yes

Full glass inner door	Yes
Removable inner door	Yes
No. total door glasses	2
No. thermo-reflective door glasses	1
Safety Thermostat	Yes
Cooling system	Tangential
Usable cavity space dimensions (HxWxD)	605x275x370 mm
Temperature control	Electro-mechanical
Circular heating element - Power	2500 W
Grill type	Electric

## Options Auxiliary Oven

Minimum Temperature	50 °C	Maximum temperature	245 °C
---------------------	-------	---------------------	--------

## Third Oven Technical Features



Net volume, 3rd cavity	36 l
Gross volume, 3rd cavity	41 l
Cavity material	Ever Clean enamel
No. of shelves	2
Type of shelves	Metal racks
No. of lights	1
Light type	Halogen
Light Power	40 W
Door opening	Flap down
Removable door	Yes
Full glass inner door	Yes

Removable inner door	Yes
No. total door glasses	3
No. of thermo-reflective door glasses	1
Safety Thermostat	Yes
Cooling system	Tangential
Usable cavity space dimensions (HxWxD)	169x440x443 mm
Temperature control	Electro-mechanical
Large grill - Power	2700 W
Grill type	Electric
Tilting grill	Yes

## Options Third Oven

Minimum Temperature	50 °C	Maximum temperature	260 °C
---------------------	-------	---------------------	--------

## Accessories included for Main Oven & Hob



Cast iron wok support	1	40mm deep tray	1
Moka stand in cast iron	1	Grill mesh	1
TOP Oven grid with back stop	2	Telescopic Guide rails, partial Extraction	1

## Accessories included for Secondary Oven



Oven grid with back stop	4	Grill mesh	1
Wide baking tray	1	Plate rack/warmer	1

## Accessories included for Third Oven

Rack with back and side stop	1	40mm deep tray	1
------------------------------	---	----------------	---

## Electrical Connection

Plug	(I) Australia	Type of electric cable installed	Yes, Single phase
Electrical connection rating	8300 W	Type of electric cable	Yes, Double and Three Phase
Current	36 A	Frequency	50/60 Hz
Voltage	220-240 V	Terminal block	5 poles
Voltage 2 (V)	380-415 V		

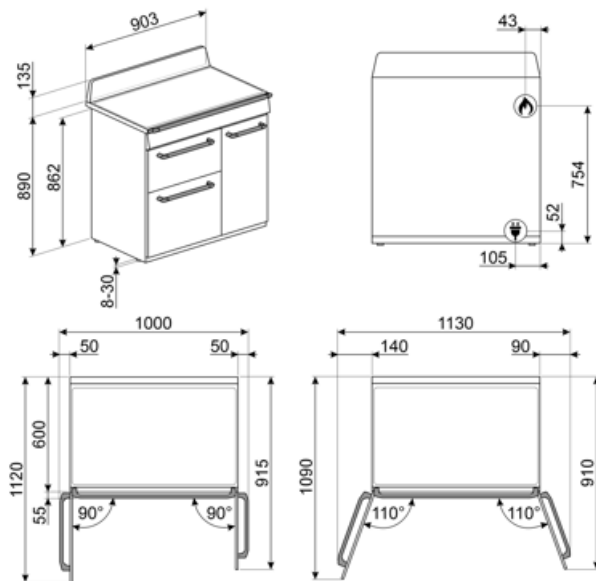

## Not included accessories

### AIRFRY

Air fryer rack AIRFRY . Ideal for recreating traditional frying in the oven, but with fewer calories and less fat. It allows you to cook quickly and simply dishes such as French fries, fried vegetables and fish, ensuring perfect browning and crispiness.



### BN620-1

Enamelled tray, 20mm deep



### BNP608T

Teflon-coated tray, 8mm depth, to be placed on the grid



### GTT

\*\*Totally extractable telescopic guides (1 level)\*\* Extraction: 433 mm Material: Stainless steel AISI 430 polished



### KITH93

Height extension kit (950 mm), suitable for TR93 cookers



### SFLK1

Child lock



### STONE

Rectangular refractory stone PPR2. Ideal for cooking pizzas with the same results as a typical wood-fired oven. Can also be used for baking bread, focaccias and other recipes such as pies, flans or biscuits Dimensions:L42 x H1,8 x P37,5 cm.



### BBQ

Double sided plate BBQ. Suitable for recreating succulent and crispy dishes in the oven with the typical taste of grilled cooking. The ribbed side is particularly suitable for meats and cheeses. The smooth side for fish, seafood and vegetables.



### BN640

Enamelled tray, 40mm deep

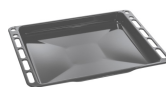

### GTP

\*\*Partially extractable telescopic guides (1 level)\*\* Extraction: 300 mm Material: Stainless steel AISI 430 polished



### KIT1TR9N

Splashback, 90x75 cm suitable for TR9 Victoria cookers, black



### PALPZ

Pizza shovel with fold away handle width: 315mm length : 325mm







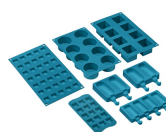

























### SMOLD

Set of 7 silicone moulds for ice creams, ice lollies, pralines, ice cubes or to portion food. Usable from -60°C to +230°C



## Symbols glossary

 <p>Heavy duty cast iron pan stands: for maximum stability and strength.</p>	 <p>Installation in column: Installation in column</p>
 <p>Knobs control</p>	 <p>Air cooling system: to ensure a safe surface temperatures.</p>
 <p>With the switch on this symbol, no heating is possible even if the thermostat is turned.</p>	 <p>Double glazed doors: Number of glazed doors.</p>
 <p>Triple glazed doors: Number of glazed doors.</p>	 <p>Enamel interior: The enamel interior of all Smeg ovens have a special antacid lining which helps keep the interior clean by reducing the amount of cooking grease adhering to it.</p>
 <p>Fan assisted base: the mix of fan and lower heating element alone allows to finish cooking foods already cooked on the surface but not internally more quickly. This system is recommended to finish cooking foods that are already well cooked on the surface, but not internally, which therefore require a moderate higher heat. Ideal for any type of food.</p>	 <p>Fan with upper and lower elements: The elements combined with the fan aim to provide more uniform heat, a similar method to conventional cooking, so pre-heat is required. Most suitable for items requiring slow cooking methods.</p>
 <p>Upper and lower element only: a traditional cooking method best suited for single items located in the centre of the oven. the top pf the oven will always be hottest. Ideal for roast, fruit cakes, bread etc.</p>	 <p>Circulaire: The combination of the fan and circular element around it gives a hot air cooking method. This provides many benefits including no preheat if cook time is more than 20 minutes, no flavour transfer when cooking different foods at the same time, less energy, and shorter cook times. Good for all types of food.</p>
 <p>ECO: The combination of the grill, fan and lower element is particularly suitable for cooking small quantities of food.</p>	 <p>Grill element: Using of grill gives excellent results when cooking meat of medium and small portions, especially when combined with a rotisserie (where possible). Also ideal for cooking sausages and bacon.</p>
 <p>Light</p>	 <p>All glass inner door: All glass inner door, a single flat surface which is simple to keep clean.</p>
 <p>The inner door glass: can be removed with a few quick movements for cleaning.</p>	 <p>Side lights: Two opposing side lights increase visibility inside the oven.</p>
 <p>Warming up: An option for dish warming and keeping the prepared meals hot.</p>	 <p>The oven cavity has 2 different cooking levels.</p>
 <p>The oven cavity has 4 different cooking levels.</p>	 <p>The oven cavity has 9 different cooking levels.</p>
 <p>Telescopic rails: allow you to pull out the dish and check it without having to remove it from the oven entirely.</p>	 <p>Electronic control: Allows you to maintain temperature inside the oven with the precision 2-3 ° C. This enables to cook meals that are very sensitive to temperature changes, such as cakes, souffles, puddings.</p>

- 
- |  |   |   |   |
|--|---|---|---|
|  | Tilting grill: the tilting grill can be easily unhooked to move the heating element and clean the roof of the appliance in one simple step. |  | Ultra rapid burners: Powerful ultra rapid burners offer up to 5kw of power.     |
|  | Vapour Clean: a simple cleaning function using steam to loosen deposits in the oven cavity.   |  | The capacity indicates the amount of usable space in the oven cavity in litres. |
|  | The capacity indicates the amount of usable space in the oven cavity in litres.   |  | The capacity indicates the amount of usable space in the oven cavity in litres. |

## Benefit (TT)

---

### **Gas hob**

Induction offers fast cooking and precise temperature control

Equipped with a thermocouple, the gas supply is cut off if the flame is extinguished for greater safety

### **Vapor Clean**

By inserting water into a recess at the bottom of the cavity, steam is generated, which softens the residue and facilitates its removal

By inserting water into a recess at the bottom of the cavity, steam is generated, which softens the residue and facilitates its removal.

### **Buttons control**

Easy and intuitive timer setting with a simple buttons

### **True-convection**

The best cooking performances guaranteed by ventilated circular flow.

Multiple fans and heating elements guarantee the perfect aerodynamic heat flow, allowing homogeneous and quicker cooking inside the cavity.

### **Multilevel cooking**

Several cooking levels allow maximum flexibility of use

### **Multilevel halogen light**

Internal halogen lighting on different levels guarantees excellent visibility

### **Removable inner glass**

Internal door glasses are easily removable for complete cleaning

### **Telescopic guides**

Easy extraction and safe insertion of trays into the oven thanks to telescopic guides

### **Isothermic Cavity**

The best cooking performance at the highest energy efficiency

### **BBQ (optional accessory)**

Barbeque cooking directly in the oven with the double-sided grill

### **Pizza stone (optional accessory)**

Baking with refractory stone for soft and crispy pizza and yeast products (STONE optional accessory)



---

**Adjustable height**

Cooker top flushed with the working area thanks to adjustable feet

**Cold door**

During any function, the external door glass is cold, avoiding any risk of burns

**AirFry (AIRFRY optional accessory)**

Lighter and tastier food thanks to airfry basket