

VR12S34

Material do lava louça
 Tipo de lava louça
 N° de cubas
 Código EAN

Aço inox
 Cuba soldada
 1
 8017709308094



Design



Design
 Design
 Cor
 Acabamentos

Universal
 Série Mira
 Aço inox
 Escovado

Instalação

Instalação à face (alinhada com a bancada), Instalação plana, Instalação inferior
 Logótipo embutido
 Lava louça sem furo para misturadora

Logótipo

Furo para a misturadora

	Tipo de cuba	Dimensões da cuba, LxPxA	Profundidade da cuba (mm)	Raio angular da cuba	Furo de escoamento de excesso de água	Posição da válvula de escoamento	Diâmetro da válvula de escoamento
Cuba	Cuba com cantos Radius	340 x 400 x 200	200	12	Furo de escoamento de excesso de água plano	Válvula de escoamento à parede	Válvula de escoamento ø 3.5"

Especificações técnicas



Dimensões do produto (mm) 201x380x440 mm
 Dimensões do furo para encastre (mm) 370*430 mm
 Dimensão do recorte sob a superfície 340*400 mm
 Raio angular para encastre 12 mm

Altura relativamente ao tampo da cozinha 1 mm
 Medida do móvel de encastre 45, 50 cm
 Número de ganchos de fixação 8

Acessórios incluídos



Fornecido com
acessórios para
instalação

Válvula de escoamento,
Sifão com ligação à
máquina de lavar louça,
Ganchos de fixação,
Silicone

Kit descarga de
resíduos

Sim

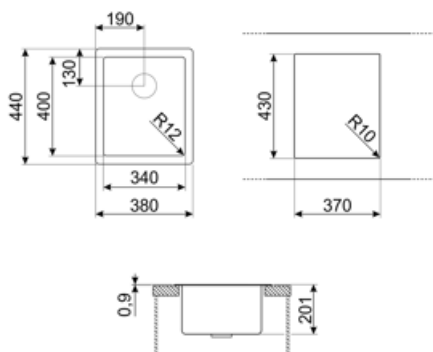

Not included accessories



CB25MN

Single HPE chopping board to fit minimum radius bowls, black matt, measures 250 x 410 H 12 mm, dishwasher safe



COL19

St/Steel colander to fit MINIMUM radius mm bowl, measures 200 x 410 x 26 mm



COL36

St/steel colander for MINIMUM radius bowls, measures 370 x 410 x 30 mm



CB28QU

Single HPL chopping board for minimum radius, oak, measures 280 x 418 H 12 mm



COL19H









St/Steel colander to fit MINIMUM radius mm bowl, measures 200 x 410 x 100 mm



KITPUSH

1 Bowl automatic pop up in AISI304 with push button ONLY for integrated waste kit bowls R12

Symbols glossary

- | | | | |
|--|--|---|--|
|  | Identifica a largura mínima, em centímetros, necessária no móvel para instalar o lava-louça |  | Cupboard width required for sink installation |
|  | Altura da cuba: Permite ter uma perceção da capacidade para receber louça. |  | O lava-louça é instalado à face com a bancada não havendo qualquer relevo entre a bancada e o lava-louça |
|  | Instalação à face. Modelos de placas e lava-louças para serem instalados à face. |  | O lava-louça é instalado debaixo da bancada, maximizando toda a bancada disponível. Esta solução é designada como cuba porque não inclui o escorredor. |
|  | A unique waste kit totally integrated with the sink gives an elegant effect and guarantees greater hygiene with the continuous surface allowing you to combine convenience with total safety during the food preparation. The new plug design is ergonomic and it's easier to extract. |  | On this sink it is not possible to install the waste disposal |

Benefit (TT)

One bowl

A single bowl for greater adaptability, capacity and space optimisation

Integrated flush waste kit

Integrated flush waste kit to maximise the efficiency of your kitchen

The fully integrated flush waste kit in stainless steel guarantees hygiene and safety during food preparation as well as giving the sink an elegant appearance