

# VR12S70

Sink material	Stainless steel
Type	Welded bowl
No. of bowls	1
EAN code	8017709308117



## Aesthetics



<b>Aesthetic Series</b>	Universale	<b>Building in type</b>	Flush fitted, Flat, Undermount
<b>Colour</b>	Stainless steel	<b>Logo</b>	Embossed
<b>Finishing</b>	Brushed	<b>Tap hole / precut tap hole</b>	No Taphole

	Bowl type	Bowl dimensions, WxDxH (mm)	Bowl depth (mm)	Radius corner bowl	Overflow	Strainer position	Strainer dimension
Bowl	Minimum radius	700 x 400 x 200	200	12	Yes, flush fitted	Wall position	3.5"

## Technical Features



<b>Dimensions of the product (mm)</b>	201x740x440 mm	<b>Height from kitchen top</b>	1 mm
<b>Cutout dimension topmount (mm)</b>	730*430 mm	<b>Base unit size</b>	80, 90 cm
<b>Cutout dimension undermount (mm)</b>	700*400 mm	<b>No. of clips</b>	10
<b>Undermount cutout radius</b>	12 mm	<b>Type of clips</b>	Standard + undermount clip

## Accessories Included



Accessories for installation

Strainer, Savespace siphon with dishwasher outlet connection, Fixing clips, Silicone

Integrated flush waste kit Yes

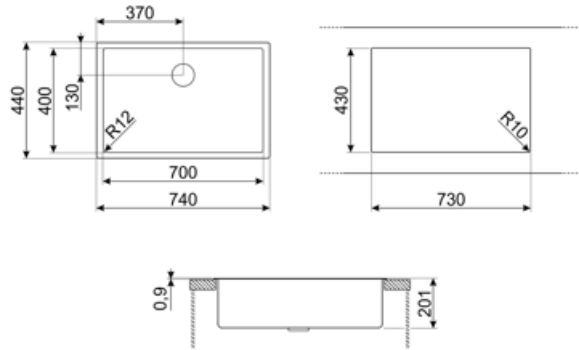

---

## Compatible Accessories

---



### CB25MN

Single HPE chopping board to fit minimum radius bowls, black matt, measures 250 x 410 H 12 mm, dishwasher safe



### COL19

St/Steel colander to fit MINIMUM radius mm bowl, measures 200 x 410 x 26 mm



### COL36

St/steel colander for MINIMUM radius bowls, measures 370 x 410 x 30 mm



### CB28QU

Single HPL chopping board for minimum radius, oak, measures 280 x 418 H 12 mm



### COL19H

St/Steel colander to fit MINIMUM radius mm bowl, measures 200 x 410 x 100 mm









### KITPUSH

1 Bowl automatic pop up in AISI304 with push button ONLY for integrated waste kit bowls R12

---

## Symbols glossary

---

- |  |   |   |  |
|--|---|---|--|
|  | Cupboard width required for sink installation   |  | Sink depth - depending on the model, the depth can be from 13 to 24,5  |
|  | Flat: Installation of product with flat edge.   |  | Flush-fitted installation: Models of sinks/hobs which are integrated flush with the tabletop of a kitchen unit.  |
|  | Under table top installation: The sink is fixed under tabletop, which extends the work surface and the depth of the sink. |  | A unique waste kit totally integrated with the sink gives an elegant effect and guarantees greater hygiene with the continuous surface allowing you to combine convenience with total safety during the food preparation. The new plug design is ergonomic and it's easier to extract. |
|  | On this sink it is not possible to install the waste disposal   |   |  |

---

## Benefit (TT)

---

### **One bowl**

A single bowl for greater adaptability, capacity and space optimisation

### **Integrated flush waste kit**

Integrated flush waste kit to maximise the efficiency of your kitchen

The fully integrated flush waste kit in stainless steel guarantees hygiene and safety during food preparation as well as giving the sink an elegant appearance