

VR12S70RS

Matériau de l'évier	Inox
Type	Cuve soudée
Nombre de cuves	1
Code EAN	8017709308162



Esthétique



Esthétique	Universel	Type d'encastrement	Affleurant, Plat
Série	Mira	Logo	Embouti
Couleur	Inox	Troué / Prépercé	2 trous d'encastrement mitigeur
Finition	Brossé		

	Type de cuve	Dimensions de la cuve en mm (L x P x H)	Profondeur de la cuve (mm)	Rayon des coins de la cuve (mm)	Trop-plein de la cuve	Position trou d'évacuation de la cuve	Dimensions du trou d'évacuation de la cuve
Cuve	Rayon minimum	700 x 400 x 200	200	12	Oui, à fil	Au mur	3.5" - 90 mm

Technologie



Dimensions du produit (mm)	201x750x510 mm	Diamètre trou mitigeur	35 mm
Dimensions de la découpe du top (mm)	735*495 mm	Commande de vidage automatique	Oui, une cuve
Hauteur depuis le plan de travail	1 mm	Type de commande de vidage automatique	Push
Mesure du meuble sous-évier	80 cm	Nombre de crochets	11
Trou d'encastrement mitigeur/ prépercé	2	Type de crochets	Standard

Accessoires inclus



Accessoires pour l'encastrement

Bonde, Siphon avec branchement lave-vaisselle, Crochets de fixation, Vidage automatique avec commande par pression

Kit de vidage intégré Oui

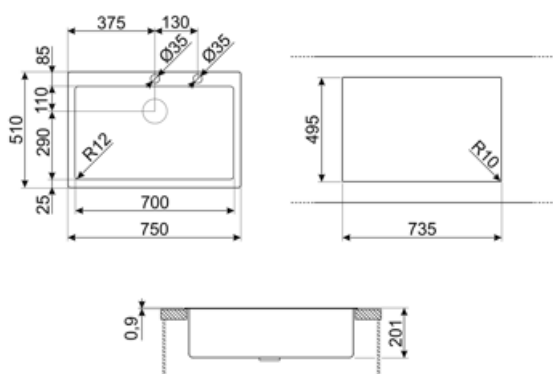

Not included accessories



CB25MN

Planche à découper simple HPE pour les cuves à rayon minimum, noir mat, dimensions 250 x 410 H 12 mm, lavable au lave-vaisselle



COL19

St/Steel colander to fit MINIMUM radius mm bowl, measures 200 x 410 x 26 mm



COL36

St/steel colander for MINIMUM radius bowls, measures 370 x 410 x 30 mm



CB28QU

Single HPL chopping board for minimum radius, oak, measures 280 x 418 H 12 mm



COL19H







St/Steel colander to fit MINIMUM radius mm bowl, measures 200 x 410 x 100 mm



KITPUSH

1 Bowl automatic pop up in AISI304 with push button ONLY for integrated waste kit bowls R12

Symbols glossary

- | | | | |
|--|--|---|---|
|  | Dimensions du meuble sous évier : Dimensions du meuble sous évier requises pour l'installation de l'évier. |  | Indique la profondeur de la cuve. |
|  | Flat : Mode d'installation approprié pour les éviers avec un bord plat, d'1 mm. |  | Affleurant : mode d'installation qui permet à l'évier et à la table de cuisson de s'intégrer parfaitement au plan de travail de la cuisine. |
|  | Kit de vidage intégré : Un kit de vidage unique totalement intégré à l'évier qui donne un effet élégant et garantit une plus grande hygiène grâce à la surface continue qui vous permet de combiner commodité et sécurité totale pendant la préparation des aliments. Le nouveau design de la bonde est ergonomique et l'extraction est plus facile. |  | Sur cet évier, il n'est pas possible d'installer l'évacuation des déchets. |

Benefit (TT)

One bowl

A single bowl for greater adaptability, capacity and space optimisation

Double tap hole

The sink is easily reversible, making it possible to create any type of kitchen composition

Pop-up command

The pop-up command allows the sink drain to be opened and closed remotely with a simple gesture and without the need to touch the plug directly, increasing convenience and hygiene in the kitchen

Pop-up command push

Attractive and modern pop-up command with push control for greater convenience in the kitchen

With the practical automatic pop-up kit with push control included, one touch is all it takes to control the movement of the drain, which opens and closes automatically ensuring greater convenience and hygiene

Tap hole

Possibility of having the tap hole for direct installation of the tap on the sink, for a larger and neater surface area

Integrated flush waste kit

Integrated flush waste kit to maximise the efficiency of your kitchen

The fully integrated flush waste kit in stainless steel guarantees hygiene and safety during food preparation as well as giving the sink an elegant appearance