

VSTR50BRX

Sink material	Stainless steel
Sink type	Single-pressed bowl
No. of bowls	1
EAN code	8017709303020



Aesthetics



Aesthetics	Universal	Building in type	Undermount
Series	Mira	Logo	Embossed
Colour	Brass	Tap hole / precut tap hole	No Taphole
Finishing	PVD Brushed		

	Bowl type	Bowl dimensions, WxDxH (mm)	Bowl depth (mm)	Radius corner bowl	Overflow	Strainer position	Strainer dimension
Bowl	Minimum radius	500 x 400 x 200	200	15	Yes, flush fitted	Wall position	3.5"

Technical Features



Characteristics composite material	Coating thickness , Eco-friendly, Pre-assembled gasket, Hypoallergenic	Tap hole diameter	35 mm
Dimensions of the product WxDxH (mm)	200x542x442 mm	No. of clips	8
Cutout dimension undermount (mm)	404*504 mm	Type of clips	Undermount clip
Base unit size	60 cm		

Accessories Included

Accessories for
installation

Strainer, Siphon with
dishwasher outlet
connection, Fixing clips

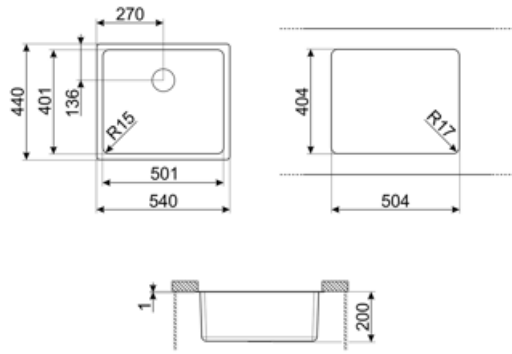

Not included accessories



3712

Siphon single bowl sinks (dishwasher connection included)



3713

Siphon double bowls sinks (dishwasher connection included)



DB34

Cestello in filo inox per abbinamento alle vasche di dimensione 340*400 mm



KITFD050

Waste disposal 0,5 HP Motor: 1/2 horsepower Fits all sinks with 3 1/2" waste outlet



KITFD075







Waste disposal 0,75 HP Motor: 3/4 horsepower Fits all sinks with 3 1/2" waste outlet



KITFD100

Waste disposal 1 HP Motor: 1 horsepower Fits all sinks with 3 1/2" waste outlet

Symbols glossary

- | | | | |
|--|---|---|---|
|  | Cupboard width required for sink installation |  | Sink depth - depending on the model, the depth can be from 13 to 24,5 |
|  | Under table top installation: The sink is fixed under tabletop, which extends the work surface and the depth of the sink. |  | Easy to clean |
|  | Coating thickness between 0.2mm and 2mm |  | PVD coatings are hypoallergenic and suitable for use in contact with food |
|  | The manufacturing process of PVD treatment is 100% green and eco-friendly | | |

Benefit

One bowl

A single bowl for greater adaptability, capacity and space optimisation