

# WDI14C7-2

EAN Code	8017709302757
Product Family	Washer dryer
Commercial width	60 cm
Commercial depth	Standard capacity
Installation	Fully integrated
Load type	Frontal



## Programmes

Controls	Electronic
Programmes graphics	Written in EN
No. of programmes	15
Programmes	

Eco 40-60

Intensive drying

 Cotton 20°

 Cotton 40°

 Cotton 60°

 Cotton 90°

 Clean

 Delicate drying

 Drain + Spin

 Mix 30°

 Quick Wash 15' 30°

 Rinse + Spin

 Synthetics 30°

 Synthetics 40°

 Wool Cold

### Washing Temperature

Cool

20°C

30°C

40°C

60°C

90°C

### Special programmes

 Wool

 Handwash

 Mix

 Quick

Special Clean programme, to remove residual fluff Yes

## Display

Residual time indicator	delay start	Recommended load indicator
programme status indication	spin regulation	

## Display type



## Buttons/Options

Prewash	Additional rinse	Anti-wrinkle (easy ironing)
Quick	Intensive	

Programme progress indicator (light)	On display
End of cycle indicator (light)	On display

## Technical Features



Type of motor	Standard	Automatic variable load	Yes
Electronic control functioning	Yes	Antifoam system	Yes
Programme/temperature selection knob	Yes	Load balancing system	Automatic
Spin speed selection on display/LED	No spin/ 600/ 800/ 1000/ 1200/ 1400	Easy to access filter	Yes
Polypropilene tank	Yes	Child lock (functions block)	Control block
Basket	Stainless steel	Anti-flood system	Yes
Drum capacity	52 l	Autocleaning system	Yes
Liquid detergent accessory as standard	Yes	Aquastop system	Total
Door diameter	30 cm	Water supply	Single, cold
Door opening	180°	Furniture door can be fitted on right or left side with adjustable hinges	Yes

## Performance / Energy Label



Washing loading capacity	7 kg	Energy consumption (washing + drying)	5.6 kWh
Drying loading capacity	4 kg	Water consumption (washing) per cycle	49 l
Max spin speed	1400 rpm	Water consumption (washing+drying) per cycle	89 l
Energy efficiency class	B	Duration of the normative programme	420 min.
Washing efficiency class	A	Energy annual consumption (washing)	260 kWh
Energy rating	BA	Energy annual consumption (washing+drying)	1120 kWh
Noise level washing	56 dB(A) re 1 pW		
Noise level spinning	72 dB(A) re 1 pW		
Noise level drying	58 dB(A) re 1 pW		

Energy consumption - 1.3 KWh  
Cotton 60° - Wash only

Water annual consumption (washing) 9800 l  
Water annual consumption (washing+drying) 17800 l  
Residual humidity percentage (%) 50 %

## Performance / Energy Label



Supplier's name or trademark SMEG

Rated capacity washing cycle 7 kg

Rated capacity complete cycle 4 kg

Energy efficiency class (washing cycle) E

Energy efficiency class (complete cycle) E

Weighted energy consumption lavaggio 77 KWh

weighted energy consumption (ciclo complete) 266 KWh

Water consumption (washing cycle) 44 litre

Water Consumption (complete cycle) 68 litre

Spin-drying efficiency class B

Airbone acoustical noise class A







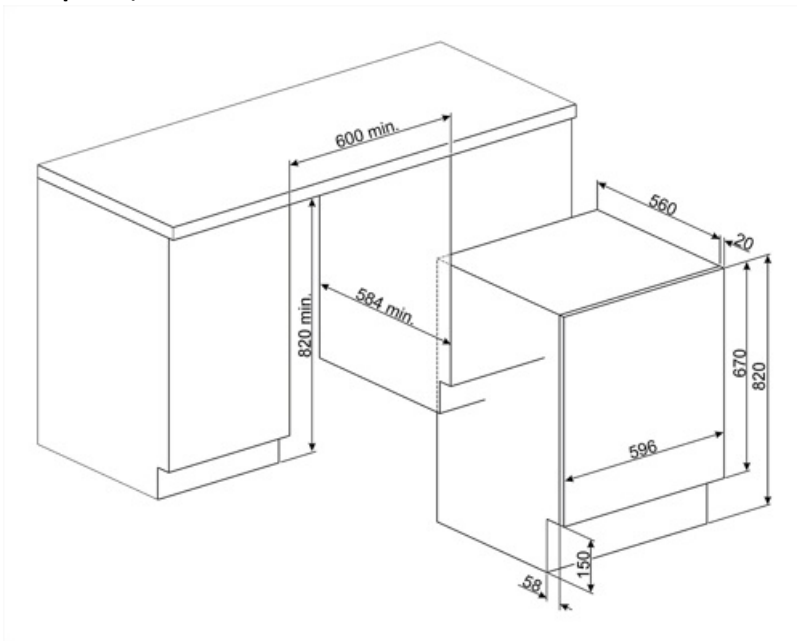









Airbone acoustical noise 72 dB(A) re 1 pW



















Programme duration at rated capacity 2:50 h:min

Programme duration at rated capacity 5:30 h:min



## Symbols glossary

-  **Total acquastop:** Most models of Smeg dishwashers are equipped with Acquastop Totale, which allows to avoid flooding as a result of water leakage. The system consists of a float sensor, disposed under the inner chamber of a dishwasher, which blocks water supply inside the appliance in case of water leakage into the lower tray. An additional electromagnetic valve on the water inlet hose also automatically blocks water supply if detecting water leakage in the hose. For Laundry: Total acquastop, the product is built with 3 levels of anti-flood devices to ensure protection against water leakage. For Laundry: Total acquastop, the product is built with 3 levels of anti-flood devices to ensure protection against water leakage.
-  **Variable load:** In all models of washing machines is present the system of variable load, according to which the machine automatically diversifies the wash cycle and the time of operation depending on the quantity and type of laundry introduced, allowing a significant saving of water and energy power, up to 30% compared to the versions with fixed load.
-  **Automatic Load Balancing:** provides an ideal distribution of laundry in the drum. In case if the imbalance is detected, the rotation speed starts being controlled in such way to evenly redistribute laundry in the drum, and thus reduce vibration.
-  **Energy efficiency class E**
-  **B:** Product energy rating, measured from A+++ to D / G depending on the product family.
-  **Gentle drying:** program designed to get laundry ready for easy ironing.
-  This option advises when the periodic cleaning of the filters is needed, in order to avoid forgetfulness and thus guarantee the perfect functioning of the dryer over time. The convenient position of the filters makes maintenance fast and extremely simple.
-  **Prewash:** program designed for heavily soiled garments.
-  **Easy Iron:** this is an option which can be selected to ensure the finished laundry is left with less creases to make ironing easier.
-  **Autocleaning system:** Autocleaning system avoids the formation of lint and impurities inside the condensation system ensuring maximum reliability of the machine
-  **Child lock:** some models are fitted with a device to lock the programme/cycle so it cannot be accidentally changed.
-  **LED display:** to show programmes, functions and options selected and the time to the end of the cycle.
-  **30 cm:** Large loading hatch of 30-32-33 cm in diameter, makes laundry loading and unloading easier and faster with maximum ease of use.
-  This shows the amount of laundry that can be inserted into the tumble dryer in KG.
-  **Intensive:** this option intensifies the selected program. Cycle duration and water consumption are reduced by taking into account the type of laundry, while still guaranteeing excellent washing results, even in the case of stains that are difficult to eliminate.
-  **Cleaning programme:** A cleaning programme has been created to maintain the performance of washer/dryers. The display shows automatically when cleaning is required.

 For lightly soiled fabrics in cotton and linen	 Cotton 40°: For soiled fabrics in cotton
 Cotton 60°: For soiled fabrics in cotton	 Cotton 90°: For soiled fabrics in cotton
 To drain the water in the machine.	 Extra Rinse: Extra Rinse: adds an extra rinse cycle to that already provided in the program chosen, to remove any residual detergent. This function is particularly suitable for those with allergies or skin problems.
 Hand wash: this specific programme for delicate fabrics uses slower rotations of the drum to ensure the utmost care for clothing.	 Mix 30°: washing program that allows to wash your cotton and synthetic clothes together without sorting them.
 Mixed fabrics: this cycle is designed for lightly soiled laundry in a mix of cottons and synthetics, or can be used just to refresh stored items.	 Rapid 15-30 ° : Rapid washing program at 30 °, let to clean slightly dirty items in a very short time.
 Super fast: a programme designed to wash small amounts of laundry fast, ideal for washing lightly soiled garments.	 To drain the water into the basket + centrifuge action
 Synthetic 30 °: washing program at 30 ° for Synthetics items	 Synthetic 40 °: washing program at 30 ° for Synthetics items
 Wool: this programme for wool or delicate fabrics uses slower rotations of the drum to ensure the utmost care for clothing.	 Wool Cold: this programme for wool or delicate fabrics uses slower rotations of the drum to ensure the utmost care for clothing.
 Option that allow to reduce times of the selected program.	 Drum has maximum capacity of 7kg of dry laundry.